

## Features

- RoHS compliant\*
- Low capacitance - 0.02 pF (I/O to I/O)
- ESD protection to IEC 61000-4-2 (Level 4)

## Applications

- USB 3.1
- USB 3.0

# CDDFN10-0516P - Surface Mount TVS Diode Array

### General Information

The CDDFN10-0516P device provides ESD protection for high-speed data ports, meeting IEC 61000-4-2 (Level 4) requirements. The Transient Voltage Suppressor array, protecting up to six data lines, offers Working Peak Reverse Voltages of 5 V (one line), 3.3 V (two lines) and 2.2 V (four lines) compatible with USB 3.1.

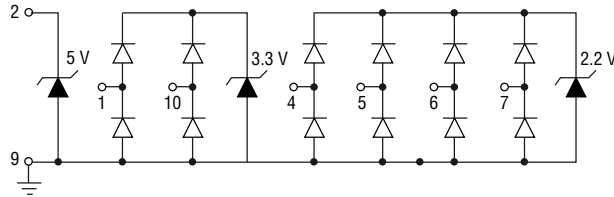

The DFN10 packaged device has an ultra-low typical capacitance of only 0.02 pF between I/O lines. This allows it to be used for protecting sensitive components used on high-speed interfaces. The small footprint of the device allows for flow-through routing on the PCB, helping to maintain matched impedances of the high-speed data lines.

### Additional Information

Click these links for more information:



[PRODUCT SELECTOR](#) [TECHNICAL LIBRARY](#) [INVENTORY](#) [SAMPLES](#) [CONTACT](#)



**WARNING**  
Cancer and Reproductive Harm  
[www.P65Warnings.ca.gov](http://www.P65Warnings.ca.gov)

\*RoHS Directive 2015/863, Mar 31, 2015 and Annex. Specifications are subject to change without notice. Users should verify actual device performance in their specific applications.

The products described herein and this document are subject to specific legal disclaimers as set forth on the last page of this document, and at [www.bourns.com/docs/legal/disclaimer.pdf](http://www.bourns.com/docs/legal/disclaimer.pdf).

### Absolute Maximum Ratings (@ T<sub>A</sub> = 25 °C Unless Otherwise Noted)

Parameter	Symbol	CDDFN10-0516P	Unit
Peak Pulse Current (t <sub>p</sub> = 8/20 μS) (1)	I <sub>pp</sub>	4	A
ESD (per IEC 61000-4-2 Contact)		10	kV
ESD (per IEC 61000-4-2 Air)		15	kV
Operating Temperature	T <sub>J</sub>	-40 to +85	°C
Storage Temperature	T <sub>STG</sub>	-55 to +150	°C

### Electrical Characteristics (@ T<sub>A</sub> = 25 °C Unless Otherwise Noted)

Pin 2 (V <sub>BUS</sub> ) to Ground					
Parameter	Symbol	Min.	Typ.	Max.	Unit
Working Peak Reverse Voltage	V <sub>WM BUS</sub>			5	V
Breakdown Voltage @ 1 mA	V <sub>BR BUS</sub>	6			V
Snap-back Voltage @ 50 mA	V <sub>SB BUS</sub>	5.5			V
Leakage Current @ V <sub>WM BUS</sub>	I <sub>R BUS</sub>			2.5	μA
Clamping Voltage @ I <sub>PP</sub> = 4 A	V <sub>C BUS</sub>		6.5		V
Channel Capacitance @ 0 V, 1 MHz	C <sub>IN BUS</sub>		17	22	pF

Pin 1 or 10 (D+, D-) to Ground (Unless Otherwise Noted)					
Parameter	Symbol	Min.	Typ.	Max.	Unit
Working Peak Reverse Voltage	V <sub>WM USB</sub>			3.3	V
Breakdown Voltage @ 1 mA	V <sub>BR USB</sub>	4.5			V
Snap-back Voltage @ 50 mA	V <sub>SB USB</sub>	3.6			V
Leakage Current @ V <sub>WM USB</sub>	I <sub>R USB</sub>			1	μA
Forward Voltage @ 15 mA	V <sub>F USB</sub>		0.9		V
Clamping Voltage @ I <sub>PP</sub> = 4 A	V <sub>C USB</sub>		7.2		V
Channel Capacitance @ 1.65 V, 1 MHz	C <sub>IN USB</sub>		0.35	0.5	pF
Channel to Channel Capacitance @ 1.65 V, 1 MHz (2) (3)	C <sub>CROSS_USB</sub>		0.02	0.04	pF

Note 1: Pin 2 (V<sub>BUS</sub>) to Ground

Note 2: Between Pins 1 and 10 (D+ to D-)

Note 3: Pin 9 = 0 V

(Continued on next page)

# CDDFN10-0516P - Surface Mount TVS Diode Array

**BOURNS®**

## Electrical Characteristics - Continued (@ T<sub>A</sub> = 25 °C Unless Otherwise Noted)

Pin 4, 5, 6 or 7 (SSTX+, SSRX+, SSTX-, SSRX-) to Ground (Unless Otherwise Noted)					
Parameter	Symbol	Min.	Typ.	Max.	Unit
Working Peak Reverse Voltage	V <sub>WM_SS</sub>			2.2	V
Breakdown Voltage @ 1 mA	V <sub>BR_SS</sub>	4.5			V
Snap-back Voltage @ 50 mA	V <sub>SB_SS</sub>	2.4			V
Leakage Current @ V <sub>WM_SS</sub>	I <sub>R_SS</sub>			1	μA
Forward Voltage @ 15 mA	V <sub>F_SS</sub>		0.9		V
Clamping Voltage @ I <sub>PP</sub> = 4 A	V <sub>C_SS</sub>		4.5		V
Channel Capacitance @ 1.2 V, 1 MHz	C <sub>IN_SS</sub>		0.35	0.5	pF
Channel to Channel Capacitance @ 1.2 V, 1 MHz (3) (4)	C <sub>CROSS_SS</sub>		0.02	0.04	pF

Note 3: Pin 9 = 0 V

Note 4: Between any two I/O; Pins 4, 5, 6 or 7 (SSTX+, SSRX+, SSTX-, SSRX-)

Specifications are subject to change without notice.

Users should verify actual device performance in their specific applications.

The products described herein and this document are subject to specific legal disclaimers as set forth on the last page of this document, and at [www.bourns.com/docs/legal/disclaimer.pdf](http://www.bourns.com/docs/legal/disclaimer.pdf).

# CDDFN10-0516P - Surface Mount TVS Diode Array

**BOURNS®**

## Performance Curves

### Typical Voltage vs. Capacitance $C_{IN}$ (4)

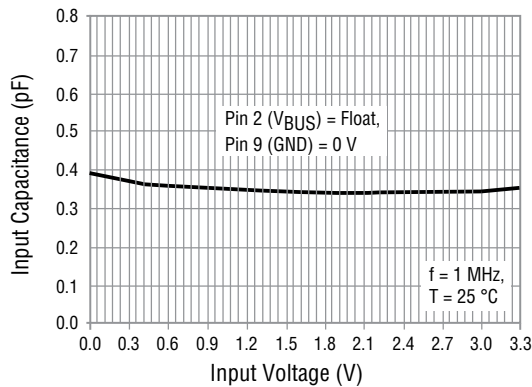

### Typical Voltage vs. Capacitance $C_{CROSS}$ (5)

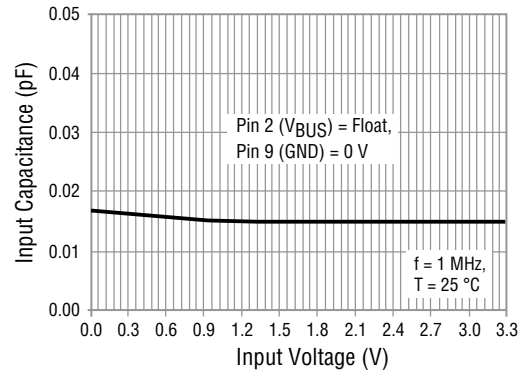

### Typical Insertion Loss $S_{21}$ (4)

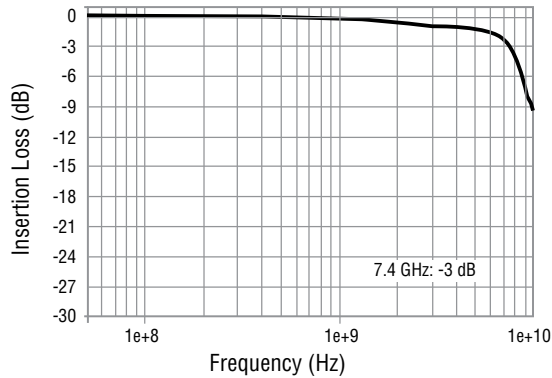

### Typical Analog Cross Talk (5)

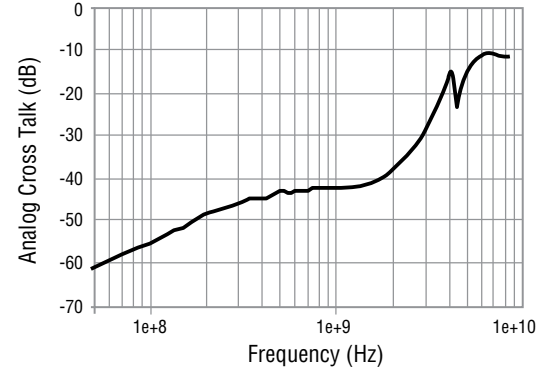

### Typical Transmission Line Pulsing (TLP)

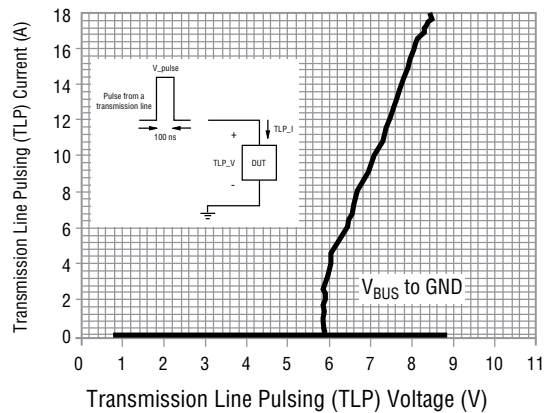

### Typical Transmission Line Pulsing (TLP)

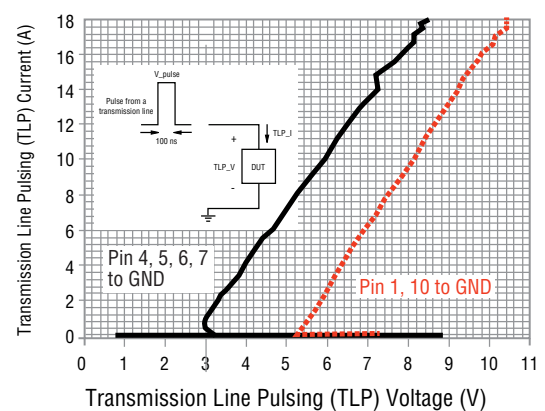

Note 4: Any I/O Pin (1, 10, 4, 5, 6, or 7) to Ground (D+, D-, SSTX+, SSRX+, SSTX-, SSRX-)

Note 5: Between any two I/O Pins (1, 10, 4, 5, 6, or 7) (D+, D-, SSTX+, SSRX+, SSTX-, SSRX-)

Specifications are subject to change without notice.

Users should verify actual device performance in their specific applications.

The products described herein and this document are subject to specific legal disclaimers as set forth on the last page of this document, and at [www.bourns.com/docs/legal/disclaimer.pdf](http://www.bourns.com/docs/legal/disclaimer.pdf).

# CDDFN10-0516P - Surface Mount TVS Diode Array

**BOURNS®**

## Applications Information

The Model CDDFN10-0516P was designed to provide ESD and surge protection for USB 3.0 and USB 3.1 applications. USB 3.x controller ICs typically have device level ESD ratings of about 2 kV per ANSI/ESDA/JEDEC JS-001-2010, to prevent ESD damage in a manufacturing environment. For this ANSI/ESDA/JEDEC JS-001-2010 test, a 100 pF cap capacitor is discharged into the device input through a 1500 ohm resistor. A system level ESD requirement is, however, typically specified to IEC 61000-4-2, which is more stringent than JESD22-A114F requirements. The IEC 61000-4-2 test discharges a 150 pF capacitor through a 330 ohm resistor. The CDDFN10-0516P is designed to enable a USB3.x controller IC to meet system ESD levels as high as 10 kV (contact test) per the IEC 61000-4-2 Standard. The device also provides up to 4 A (8/20  $\mu$ S) of surge protection on the 5 V  $V_{BUS}$  line per IEC 61000-4-5.

The Bourns® Model CDDFN10-0516P provides protection for six signal lines and a 5 V power bus. Its ultra-low capacitance minimizes signal distortion on USB 3.1 super-speed data lines with 10 Gbps data rates. The figure below shows the connection diagram for one port of a USB 3.x application. USB 3.1 provides three voltage/current options for bus power: 5 V @ up to 2 A, 12 V @ up to 5 A and 20 V @ up to 5 A. The  $V_{BUS}$  line should only be connected to Pin 2 of the CDDFN10-0516P device if the bus voltage is limited to the 5 V option. In cases where the bus voltage is 12 V or 20 V, a separate device is required to protect the  $V_{BUS}$  line.

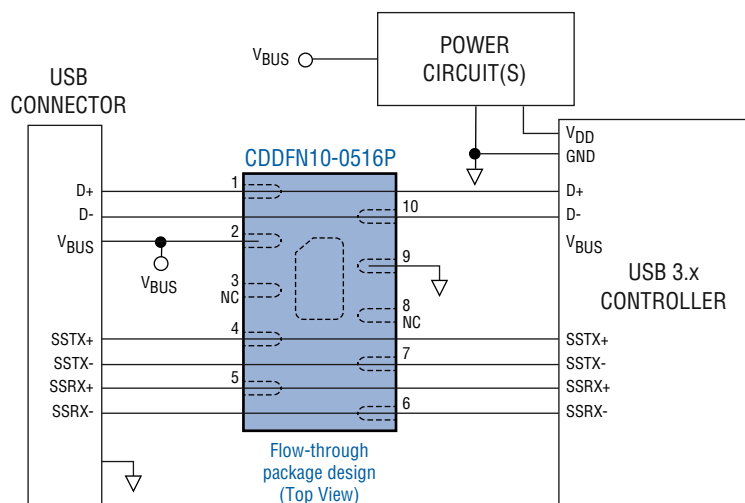

The flow-through package design of the Model CDDFN10-0516P simplifies signal routing on the printed circuit board. This minimizes the effect of the device connection on the signal line impedance and on system performance. The 10 Gbps eye diagrams below show that the loading of Pins 4 through 7 has a minimal impact on the performance of the USB 3.1 super-speed data lines.

Performance Without Protection

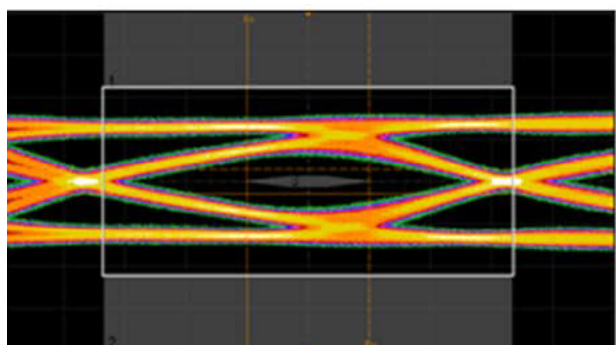

-15 ps 0 +15 ps

Performance With Protection

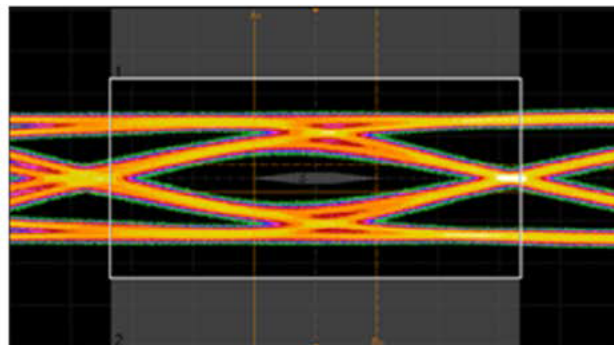

-15 ps 0 +15 ps

Specifications are subject to change without notice.

Users should verify actual device performance in their specific applications.

The products described herein and this document are subject to specific legal disclaimers as set forth on the last page of this document, and at [www.bourns.com/docs/legal/disclaimer.pdf](http://www.bourns.com/docs/legal/disclaimer.pdf).

# CDDFN10-0516P - Surface Mount TVS Diode Array



## Product Dimensions

This is a molded DFN10 package with lead free 100 % Matte Sn on the lead frame. It has a flammability rating of UL 94V-0.

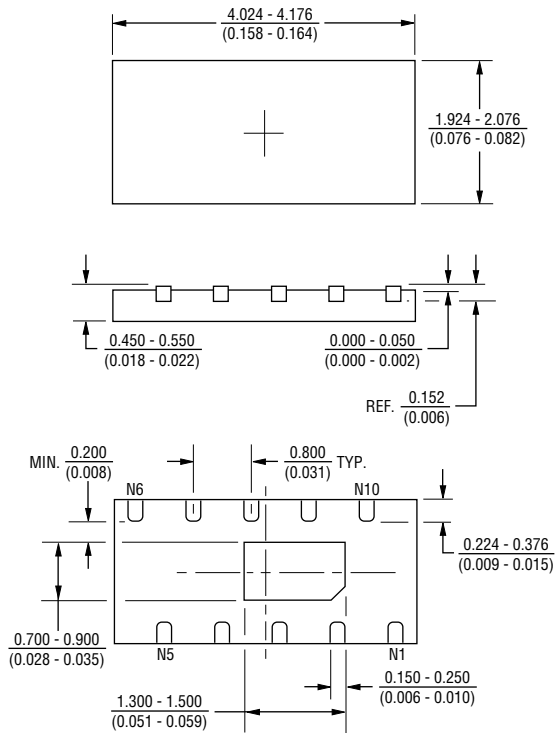

## Recommended Footprint

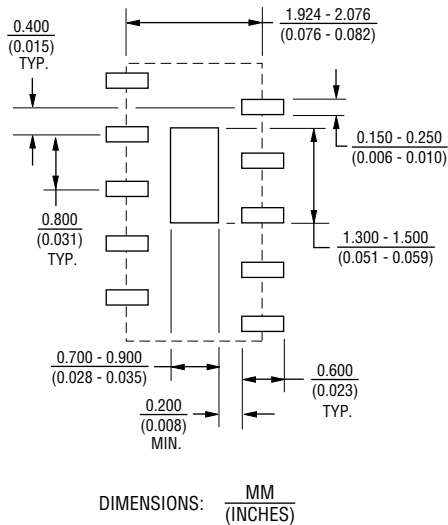

## Device Pinout

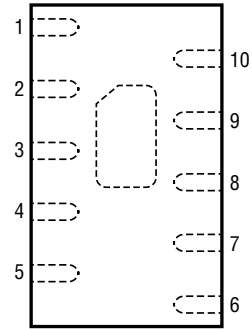

(Top View)

Pin	Function
1, 10	D+, D- (USB Differential Pair)
2	VBUS
3, 8	N.C.
4, 5, 6, 7	SSTX+, SSTX-, SSRX+, SSRX- (Super-Speed Pairs)
9	Ground
Center Pad	Ground

## Typical Part Marking

CDDFN10-0516P ..... 516

## How to Order

**CD DFN10 - 05 16 P**

Common Diode \_\_\_\_\_  
 Chip Diode \_\_\_\_\_  
 Package \_\_\_\_\_  
 DFN10 = DFN-10 Package  
 Working Peak Voltage \_\_\_\_\_  
 05 = 5 V<sub>RWM</sub> (Volts)  
 Number of Lines \_\_\_\_\_  
 16 = 1 Ground / 6 Data Lines  
 Suffix \_\_\_\_\_  
 P = Ultra-low Capacitance

Specifications are subject to change without notice.

Users should verify actual device performance in their specific applications.

The products described herein and this document are subject to specific legal disclaimers as set forth on the last page of this document, and at [www.bourns.com/docs/legal/disclaimer.pdf](http://www.bourns.com/docs/legal/disclaimer.pdf).

# CDDFN10-0516P - Surface Mount TVS Diode Array

**BOURNS®**

## Packaging Information

The product is packaged in an 8 mm x 4 mm tape and reel format per EIA-481-A standard.

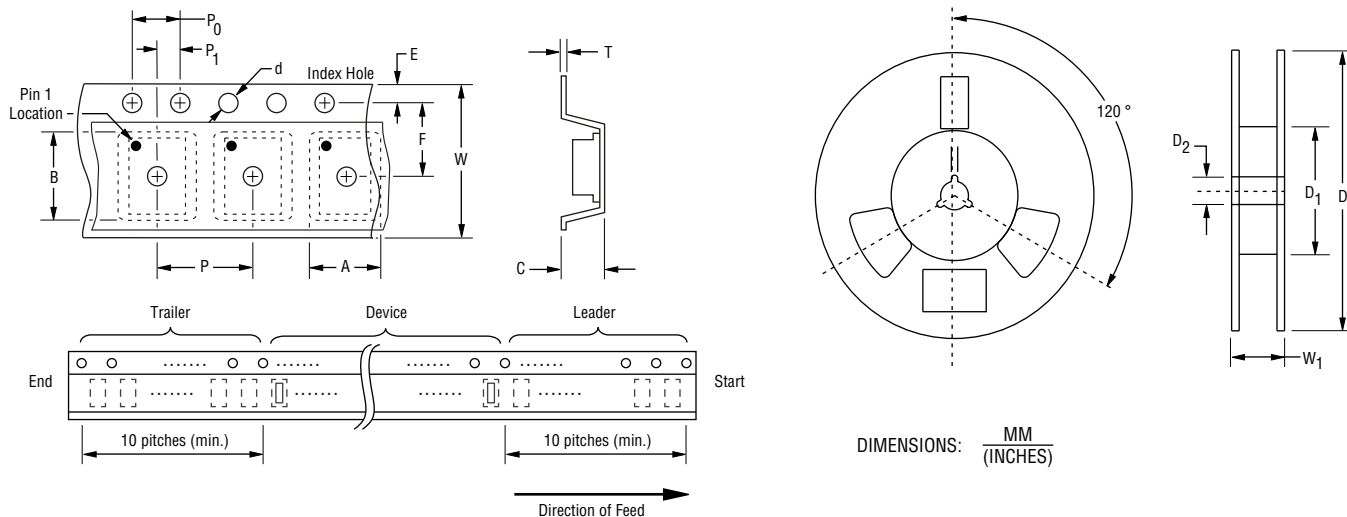

Item	Symbol	DFN-10
Carrier Width	A	$\frac{2.21 \pm 0.05}{(0.087 \pm 0.002)}$
Carrier Length	B	$\frac{4.22 + 0.05/-0.04}{(0.166 + 0.002/-0.002)}$
Carrier Depth	C	$\frac{0.81 \pm 0.05}{(0.032 \pm 0.002)}$
Sprocket Hole	d	$\frac{1.50 + 0.1/-0}{(0.059 + 0.004/-0)}$
Reel Outside Diameter	D	$\frac{180 \pm 3}{(7.087 \pm .118)}$
Reel Inner Diameter	D <sub>1</sub>	$\frac{50.0}{(1.969)}$ MIN.
Feed Hole Diameter	D <sub>2</sub>	$\frac{13.0 + 0.5/-0.2}{(0.512 + 0.020/-0.008)}$
Sprocket Hole Position	E	$\frac{1.75 \pm 0.10}{(0.069 \pm 0.004)}$
Punch Hole Position	F	$\frac{5.50 \pm 0.05}{(0.217 \pm 0.002)}$
Punch Hole Pitch	P	$\frac{4.00 \pm 0.10}{(0.157 \pm 0.004)}$
Sprocket Hole Pitch	P <sub>0</sub>	$\frac{4.00 \pm 0.10}{(0.157 \pm 0.004)}$
Embossment Center	P <sub>1</sub>	$\frac{2.00 \pm 0.05}{(0.079 \pm 0.002)}$
Overall Tape Thickness	T	$\frac{0.6}{(0.024)}$ MAX.
Tape Width	W	$\frac{12.3}{(0.484)}$ MAX.
Reel Width	W <sub>1</sub>	$\frac{18.4}{(0.724)}$ MAX.
Quantity per Reel	--	3000

**BOURNS®**

**Asia-Pacific:** Tel: +886-2 2562-4117

Email: asiacus@bourns.com

**EMEA:** Tel: +36 88 885 877

Email: eurocus@bourns.com

**The Americas:** Tel: +1-951 781-5500

Email: americus@bourns.com

**www.bourns.com**

REV. 08/19

Specifications are subject to change without notice. Users should verify actual device performance in their specific applications. The products described herein and this document are subject to specific legal disclaimers as set forth on the last page of this document, and at [www.bourns.com/docs/legal/disclaimer.pdf](http://www.bourns.com/docs/legal/disclaimer.pdf).

This legal disclaimer applies to purchasers and users of Bourns® products manufactured by or on behalf of Bourns, Inc. and its affiliates (collectively, “Bourns”).

Unless otherwise expressly indicated in writing, Bourns® products and data sheets relating thereto are subject to change without notice. Users should check for and obtain the latest relevant information and verify that such information is current and complete before placing orders for Bourns® products.

The characteristics and parameters of a Bourns® product set forth in its data sheet are based on laboratory conditions, and statements regarding the suitability of products for certain types of applications are based on Bourns’ knowledge of typical requirements in generic applications. The characteristics and parameters of a Bourns® product in a user application may vary from the data sheet characteristics and parameters due to (i) the combination of the Bourns® product with other components in the user’s application, or (ii) the environment of the user application itself. The characteristics and parameters of a Bourns® product also can and do vary in different applications and actual performance may vary over time. Users should always verify the actual performance of the Bourns® product in their specific devices and applications, and make their own independent judgments regarding the amount of additional test margin to design into their device or application to compensate for differences between laboratory and real world conditions.

Unless Bourns has explicitly designated an individual Bourns® product as meeting the requirements of a particular industry standard (e.g., ISO/TS 16949) or a particular qualification (e.g., UL listed or recognized), Bourns is not responsible for any failure of an individual Bourns® product to meet the requirements of such industry standard or particular qualification. Users of Bourns® products are responsible for ensuring compliance with safety-related requirements and standards applicable to their devices or applications.

Bourns® products are not recommended, authorized or intended for use in nuclear, lifesaving, life-critical or life-sustaining applications, nor in any other applications where failure or malfunction may result in personal injury, death, or severe property or environmental damage. Unless expressly and specifically approved in writing by two authorized Bourns representatives on a case-by-case basis, use of any Bourns® products in such unauthorized applications might not be safe and thus is at the user’s sole risk. Life-critical applications include devices identified by the U.S. Food and Drug Administration as Class III devices and generally equivalent classifications outside of the United States.

Bourns expressly identifies those Bourns® standard products that are suitable for use in automotive applications on such products’ data sheets in the section entitled “Applications.” Unless expressly and specifically approved in writing by two authorized Bourns representatives on a case-by-case basis, use of any other Bourns® standard products in an automotive application might not be safe and thus is not recommended, authorized or intended and is at the user’s sole risk. If Bourns expressly identifies a sub-category of automotive application in the data sheet for its standard products (such as infotainment or lighting), such identification means that Bourns has reviewed its standard product and has determined that if such Bourns® standard product is considered for potential use in automotive applications, it should only be used in such sub-category of automotive applications. Any reference to Bourns® standard product in the data sheet as compliant with the AEC-Q standard or “automotive grade” does not by itself mean that Bourns has approved such product for use in an automotive application.

Bourns® standard products are not tested to comply with United States Federal Aviation Administration standards generally or any other generally equivalent governmental organization standard applicable to products designed or manufactured for use in aircraft or space applications. Bourns expressly identifies Bourns® standard products that are suitable for use in aircraft or space applications on such products’ data sheets in the section entitled “Applications.” Unless expressly and specifically approved in writing by two authorized Bourns representatives on a case-by-case basis, use of any other Bourns® standard product in an aircraft or space application might not be safe and thus is not recommended, authorized or intended and is at the user’s sole risk.

The use and level of testing applicable to Bourns® custom products shall be negotiated on a case-by-case basis by Bourns and the user for which such Bourns® custom products are specially designed. Absent a written agreement between Bourns and the user regarding the use and level of such testing, the above provisions applicable to Bourns® standard products shall also apply to such Bourns® custom products.

Users shall not sell, transfer, export or re-export any Bourns® products or technology for use in activities which involve the design, development, production, use or stockpiling of nuclear, chemical or biological weapons or missiles, nor shall they use Bourns® products or technology in any facility which engages in activities relating to such devices. The foregoing restrictions apply to all uses and applications that violate national or international prohibitions, including embargos or international regulations. Further, Bourns® products and Bourns technology and technical data may not under any circumstance be exported or re-exported to countries subject to international sanctions or embargoes. Bourns® products may not, without prior authorization from Bourns and/or the U.S. Government, be resold, transferred, or re-exported to any party not eligible to receive U.S. commodities, software, and technical data.

To the maximum extent permitted by applicable law, Bourns disclaims (i) any and all liability for special, punitive, consequential, incidental or indirect damages or lost revenues or lost profits, and (ii) any and all implied warranties, including implied warranties of fitness for particular purpose, non-infringement and merchantability.

*For your convenience, copies of this Legal Disclaimer Notice with German, Spanish, Japanese, Traditional Chinese and Simplified Chinese bilingual versions are available at:*

*Web Page:* <http://www.bourns.com/legal/disclaimers-terms-and-policies>

*PDF:* <http://www.bourns.com/docs/Legal/disclaimer.pdf>