



## Features

- High-speed performance
- Superior overcurrent protection
- Bidirectional
- Low resistance
- Excellent channel to channel resistance matching
- Small SMT package

■ RoHS compliant\* and halogen free\*\*

## TCS-DL Series - TCS™ Dual Transient Current Suppressors

### General Information

The Bourns® TCS™ DL Series High-Speed Protector products contain dual, well-matched, low resistance, bidirectional, very high-speed Transient Current Suppressors. By limiting the maximum current to a safe level, a Bourns® TCS™ DL device offers superior protection for very high data rate differential lines against faults caused by short circuits, induction and lightning surges.

Bourns® TCS™ High-Speed Protectors are typically used in conjunction with low capacitance TVS devices to form an extremely low let-through energy barrier to excessive voltages and currents during surge events which may cause damage to unprotected high-speed, low voltage driver and receiver components.

The Bourns® TCS™ High-Speed Protector is provided in a space-saving, surface mount DFN package meeting industry standard requirements such as RoHS and Pb Free solder reflow profiles.

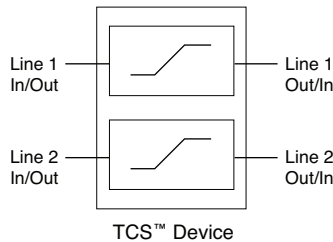

### Additional Information

Click these links for more information:



### Absolute Maximum Ratings (@ T<sub>A</sub> = 25 °C Unless Otherwise Noted)

Symbol	Parameter	Value	Unit
V <sub>imp</sub>	Peak impulse voltage withstand with duration less than 1 ms	40	V
T <sub>op</sub>	Operating temperature range	-55 to +125	°C
T <sub>stg</sub>	Storage temperature range	-65 to +150	°C
T <sub>JMAX</sub>	Maximum junction temperature	+125	°C

### Electrical Characteristics (@ T<sub>A</sub> = 25 °C Unless Otherwise Noted)

Symbol	Parameter	Part Number	Min.	Typ.	Max.	Unit
I <sub>trigger</sub>	Current required for the device to go from operating state to protected state	TCS-DL004-250-WH TCS-DL004-750-WH	250 750	375 1100	500 1500	mA
R <sub>ON</sub>	Series resistance of the TCS™ device	TCS-DL004-250-WH TCS-DL004-750-WH	1.6 0.7	2.3 1.0	3.0 1.3	Ω
ΔR <sub>ON</sub>	Channel to channel resistance match	TCS-DL004-250-WH TCS-DL004-750-WH			±0.05 ±0.02	Ω
t <sub>limit</sub>	Time for the device to go from normal operating state to current limiting state			50		ns
R <sub>θJA</sub>	Junction to air thermal resistance, FR4 PCB. 0.035 sq. in. of copper in addition to solder pads			130		°C/W



**WARNING**  
Cancer and Reproductive Harm  
[www.P65Warnings.ca.gov](http://www.P65Warnings.ca.gov)

\* RoHS Directive 2015/863, Mar 31, 2015 and Annex.

\*\* Bourns considers a product to be "halogen free" if (a) the Bromine (Br) content is 900 ppm or less; (b) the Chlorine (Cl) content is 900 ppm or less; and (c) the total Bromine (Br) and Chlorine (Cl) content is 1500 ppm or less.

Specifications are subject to change without notice.

Users should verify actual device performance in their specific applications. The products described herein and this document are subject to specific legal disclaimers as set forth on the last page of this document, and at [www.bourns.com/docs/legal/disclaimer.pdf](http://www.bourns.com/docs/legal/disclaimer.pdf).

## Applications

- VDSL and Ethernet ports
- Protection modules and dongles
- Process control equipment
- Test and measurement equipment

# TCS-DL Series - TCS™ Dual Transient Current Suppressors

# BOURNS®

### Performance Graphs

Graph 1 below shows a normalized Typical V-I curve for Bourns® TCS™ DL Series High-Speed Protector products under surge conditions. Graphs 2 and 3 show the change in resistance and trip current versus temperature, respectively.

#### Normalized V-I Curve Under Surge Conditions

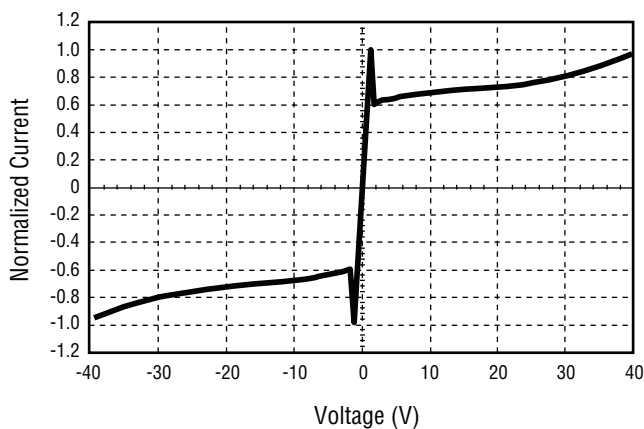

#### Resistance Change vs. Temperature

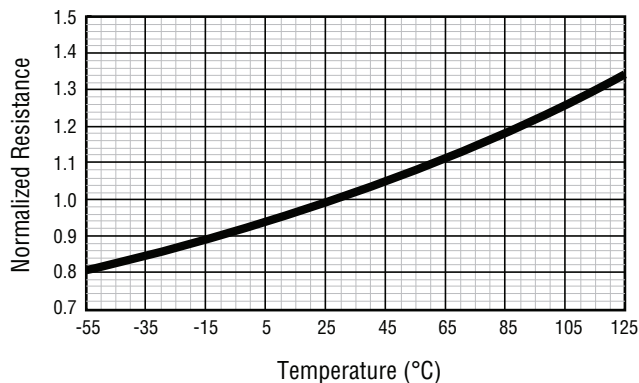

#### Trip Current Change vs. Temperature

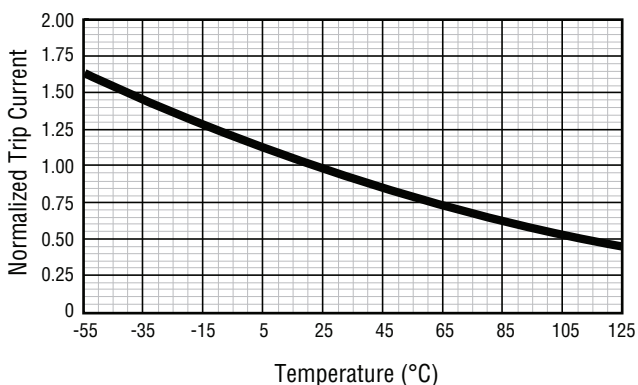

### Basic Device Operation

The Bourns® TCS™ High-Speed Protector is designed to be used in conjunction with a suitable overvoltage limiting device, such as a TVS diode or a TISP® thyristor as shown below, to provide comprehensive current and voltage limiting protection against surges.

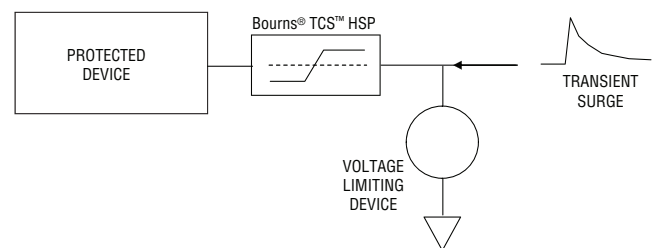

*Coordination of Bourns® TCS™ High-Speed Protector with Overvoltage Limiting Device*

This two-stage protection limits the maximum voltage at the interface to the clamping voltage of the overvoltage device, while also limiting the current into the protected device to the defined limit of the Bourns® TCS™ High-Speed Protector. Designers should choose a Bourns® TCS™ High-Speed Protector with a current limit that the protected device can handle for the duration of the surge event.

The Bourns® TCS™ High-Speed Protector acts like a low value resistor during normal operation. As the Bourns® TCS™ High-Speed Protector has no electrical connection to anything other than the signal line it protects, the capacitance to ground is purely dictated by the capacitance of the device to surrounding components and PCB traces, which with careful layout can be kept to an absolute minimum.

The Bourns® TCS™ High-Speed Protector can block voltages up to 40 V. This enables very low voltage electronics to be protected by a lower capacitance, higher voltage TVS device, thus achieving very low capacitive loading on high-speed signal lines. For example, on a 3.3 V driver, a 12 V rated TVS may be used, having much lower and more linear capacitance than a lower voltage type. Even though a high voltage TVS is used, the maximum stress seen by the protected device is much lower than would be seen by using a low voltage TVS by itself, as the current is limited to within the maximum limits of the Bourns® TCS™ High-Speed Protector.

The Bourns® TCS™ High-Speed Protector is primarily designed to offer superior and cost-effective protection of sensitive electronics against high energy surges that are transient in nature. Unlike the more complex TBU® High-Speed Protector device, the TCS™ Protector does not exhibit a strong foldback

Specifications are subject to change without notice. Users should verify actual device performance in their specific applications. The products described herein and this document are subject to specific legal disclaimers as set forth on the last page of this document, and at [www.bourns.com/docs/legal/disclaimer.pdf](http://www.bourns.com/docs/legal/disclaimer.pdf).

**Basic Device Operation (Continued)**

characteristic after reaching the current limit, and therefore doesn't protect against DC and low frequency stresses (typically achieved through the use of a transformer or capacitive coupling). This is analogous to comparing the shunting characteristics of a Transient Voltage Suppressor device to a thyristor type of protector, such as Bourns® TISP® devices. Both the Bourns® TCS™ High-Speed Protector and TVS

device have limited or no foldback characteristic, and therefore have relatively low short term surge energy limits. When used together in a protection circuit, the surge must not exceed the thermal capability of either device. The following three graphs show the maximum surge duration with respect to voltage of the three TCS-DL devices at both +25 °C and +85 °C.

**TCS-DL004-250-WH SOA Single Surge Duration**

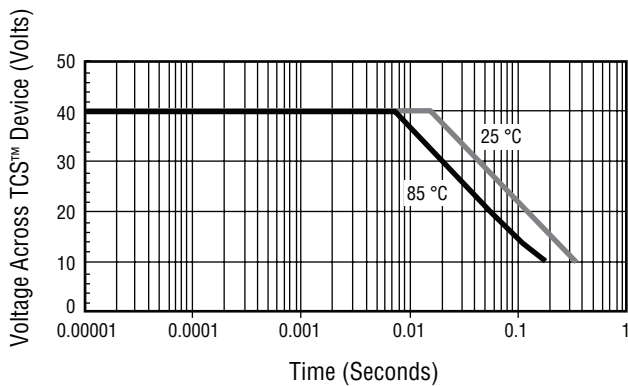

**TCS-DL004-750-WH SOA Single Surge Duration**

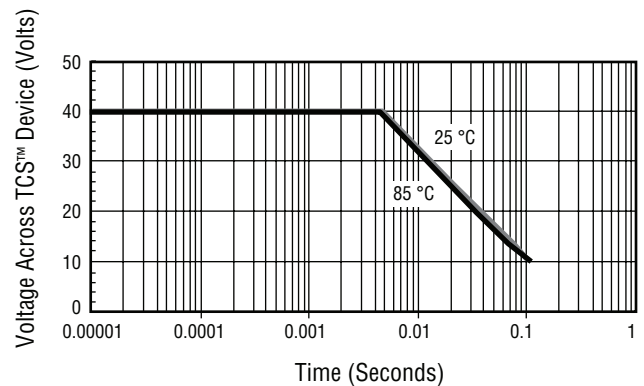

Specifications are subject to change without notice.

Users should verify actual device performance in their specific applications.

The products described herein and this document are subject to specific legal disclaimers as set forth on the last page of this document, and at [www.bourns.com/docs/legal/disclaimer.pdf](http://www.bourns.com/docs/legal/disclaimer.pdf).

**Basic Device Operation (Continued)**

**COORDINATION**

In all applications, the overvoltage protection device should be chosen to limit the maximum voltage across the Bourns® TCS™ High-Speed Protector to less than the maximum voltage rating of the device. If this maximum voltage limit is exceeded, the Bourns® TCS™ High-Speed Protector may begin to avalanche, and it will cease to effectively block the current into the protected device, which may result in damage.

**USING MULTIPLE TCS-DL DEVICES IN SERIES OR PARALLEL**

Bourns® TCS™ High-Speed Protectors may be connected in parallel to achieve even lower on-state resistance. If matching is required, use two Bourns® TCS-DL Series HSPs, and connect one Bourns® TCS™ High-Speed Protector from each DL device in parallel. In addition, because of their ultra-fast response, multiple Bourns® TCS™ High-Speed Protectors may be connected in series to achieve multiples of the breakdown voltage.

**Reference Applications**

Two good examples of applications where the combination of a Bourns® TCS™ High-Speed Protector and a voltage limiting device provides exceptional performance are in VDSL and

Ethernet circuits, where the line is driven differentially by a transformer.

**VDSL**

In the VDSL application shown below, the transformer provides additional protection against sustained DC faults and the coupling capacitors, C1 and C2, provide protection against DC and mains frequency power faults. The termination resistors

R1 and R2 are reduced in value by the nominal resistance of the Bourns® TCS™ High-Speed Protector to maintain the overall termination resistance.

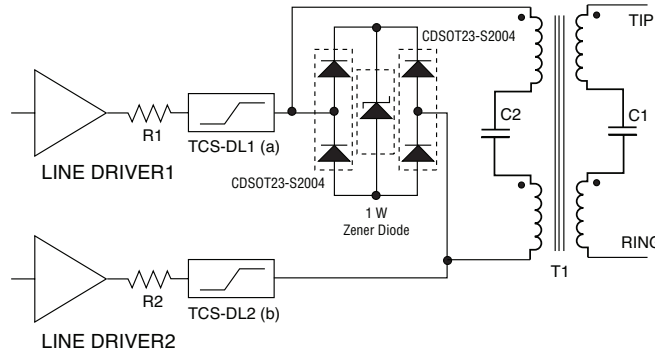

Basic Schematic of a VDSL Line Driver Stage

**GbE**

In the Gigabit Ethernet (GbE) application circuit shown below, the transformer provides additional protection against sustained DC faults and provides some isolation from surge conditions such as lightning strikes. The TCS™ device limits the current that the PHY will be subjected to under a surge condition. It also

provides voltage isolation so that the peak voltage that the PHY is subjected to will be lower than the TVS diode clamp voltage. The TVS diode will sink the majority of the transformer secondary current and clamp the voltage to a level that is below the 40 V maximum rating of the TCS™ device.

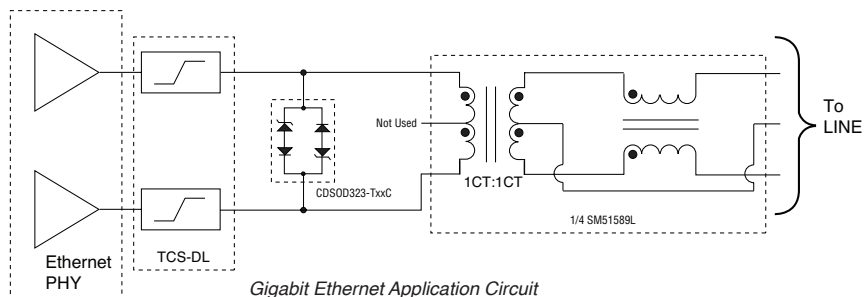

Gigabit Ethernet Application Circuit

Specifications are subject to change without notice.

Users should verify actual device performance in their specific applications.

The products described herein and this document are subject to specific legal disclaimers as set forth on the last page of this document, and at [www.bourns.com/docs/legal/disclaimer.pdf](http://www.bourns.com/docs/legal/disclaimer.pdf).

**Product Dimensions**

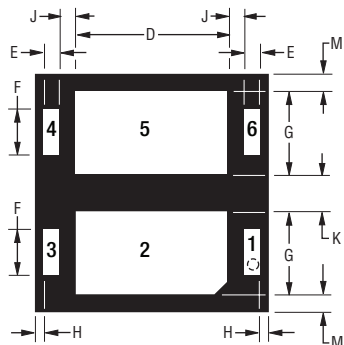
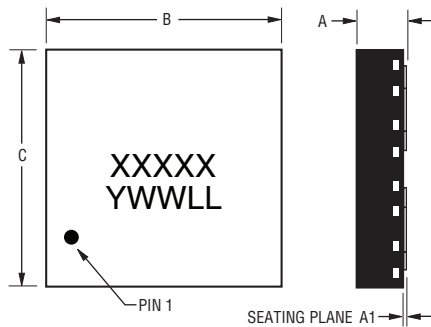

DIMENSIONS:  
MM  
INCHES

Dim.	TCS-DL004-250-WH			TCS-DL004-750-WH		
	Min.	Typ.	Max.	Min.	Typ.	Max.
A	0.80 (.031)	0.90 (.035)	1.00 (.039)	0.80 (.031)	0.90 (.035)	1.00 (.039)
A1	0.00 (.000)	0.025 (.001)	0.05 (.002)	0.00 (.000)	0.025 (.001)	0.05 (.002)
B	2.40 (.094)	2.50 (.098)	2.60 (.102)	4.4 (.173)	4.5 (.177)	4.6 (.181)
C	3.90 (.154)	4.00 (.157)	4.10 (.161)	3.90 (.154)	4.00 (.157)	4.10 (.161)
D	1.05 (.041)	1.10 (.043)	1.15 (.045)	3.05 (.120)	3.10 (.122)	3.15 (.124)
E	0.20 (.008)	0.25 (.010)	0.30 (.012)	0.20 (.008)	0.25 (.010)	0.30 (.012)
F	0.75 (.030)	0.8 (.031)	0.85 (.033)	0.75 (.030)	0.8 (.031)	0.85 (.033)
G	1.40 (.055)	1.45 (.057)	1.50 (.059)	1.40 (.055)	1.45 (.057)	1.50 (.059)
H	0.10 (.004)	0.15 (.006)	0.20 (.008)	0.10 (.004)	0.15 (.006)	0.20 (.008)
J	0.25 (.010)	0.30 (.012)	0.35 (.014)	0.25 (.010)	0.30 (.012)	0.35 (.014)
K	0.55 (.022)	0.60 (.024)	0.65 (.026)	0.55 (.022)	0.60 (.024)	0.65 (.026)
M	0.20 (.008)	0.25 (.010)	0.30 (.012)	0.20 (.008)	0.25 (.010)	0.30 (.012)

**Recommended Pad Layout**

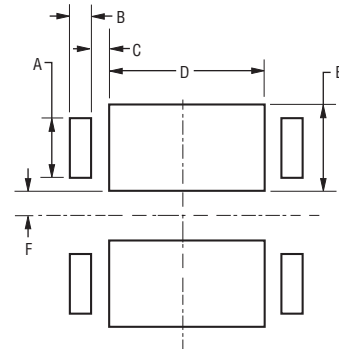

Dim.	TCS-DL004-250-WH	TCS-DL004-750-WH
A	0.80 (.031)	0.80 (.031)
B	0.25 (.010)	0.25 (.010)
C	0.30 (.012)	0.30 (.012)
D	1.1 (.043)	3.1 (.122)
E	1.45 (.057)	1.45 (.057)
F	0.30 (.012)	0.30 (.012)

DIMENSIONS:  $\frac{\text{MM}}{\text{(INCHES)}}$

**Pad Designation**

Pad #	Apply	Pad #	Apply
1	Line 1 In/Out	4	Line 2 Out/In
2	No Connection	5	No Connection
3	Line 1 Out/In	6	Line 2 In/Out

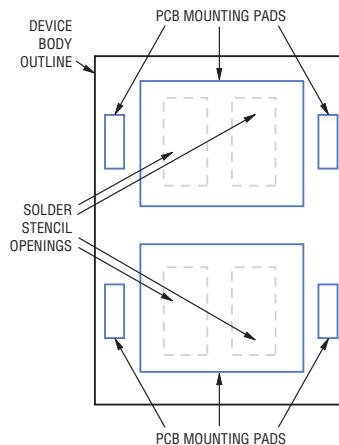

Bourns® TCS™ High-Speed Protectors have a matte-tin termination. The recommended solder stencil thickness is 0.10 to 0.12 mm (0.004 to 0.005 in.). The stencil opening for pins 1,3,4 and 6 should be the same size as the recommended PCB pad size. The stencil openings for pins 2 and 5 of the device should cover 60-70 % of the area of the PCB pad and should be divided into smaller areas as shown in the solder stencil figure.

Specifications are subject to change without notice.

Users should verify actual device performance in their specific applications.

The products described herein and this document are subject to specific legal disclaimers as set forth on the last page of this document, and at [www.bourns.com/docs/legal/disclaimer.pdf](http://www.bourns.com/docs/legal/disclaimer.pdf).

# TCS-DL Series - TCS™ Dual Transient Current Suppressors

**BOURNS®**

## How to Order

**TCS - DL 004 - 250 - WH**

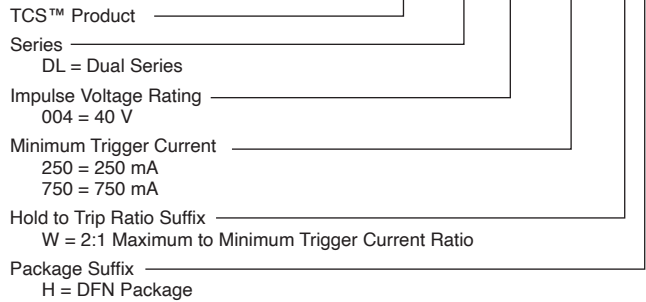

## Typical Part Marking



PIN 1

MANUFACTURING  
DATE CODE:

- 1ST DIGIT INDICATES THE YEAR.
- 2ND & 3RD DIGITS INDICATE THE WEEK NUMBER.
- 4TH & 5TH DIGITS INDICATE LOT CODE.

- 5 DIGIT PRODUCT CODE:
  - 1ST ALPHA CHARACTER INDICATES PRODUCT FAMILY:
    - D = TCS-DL SERIES
  - 2ND & 3RD DIGITS INDICATE IMPULSE VOLTAGE.
  - 4TH & 5TH DIGITS INDICATE TRIGGER CURRENT.

Specifications are subject to change without notice.

Users should verify actual device performance in their specific applications.

The products described herein and this document are subject to specific legal disclaimers as set forth on the last page of this document, and at [www.bourns.com/docs/legal/disclaimer.pdf](http://www.bourns.com/docs/legal/disclaimer.pdf).

# TCS-DL Series - TCS™ Dual Transient Current Suppressors



## Packaging Specifications

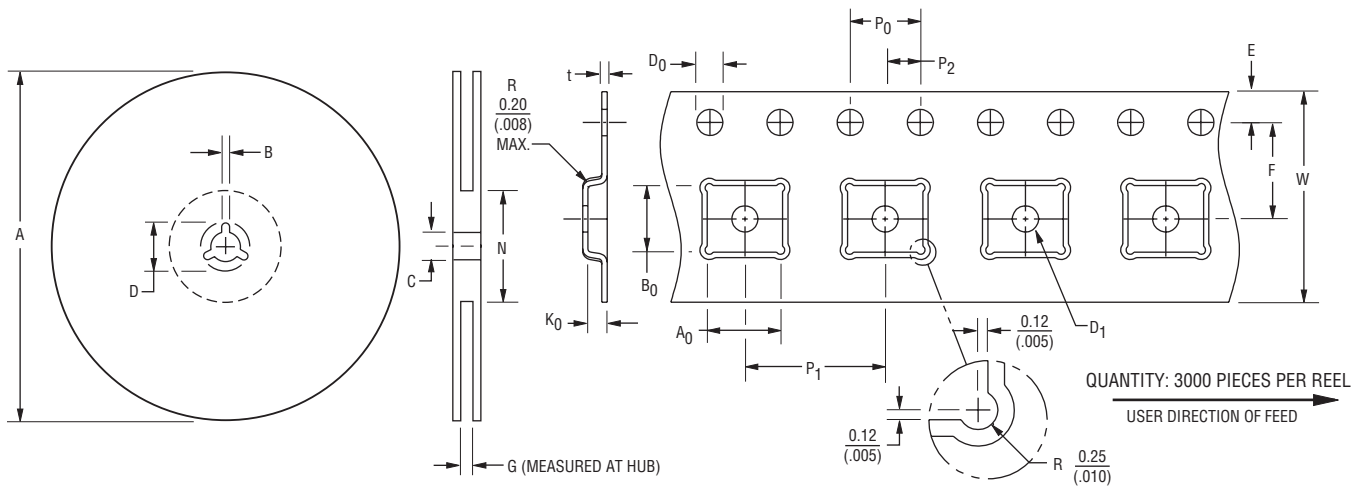

A		B		C		D		G	
Min.	Max.	Min.	Max.	Min.	Max.	Min.	Max.	Min.	Max.
<u>326</u>	<u>330</u>	<u>1.5</u>	<u>2.5</u>	<u>12.8</u>	<u>13.5</u>	<u>20.2</u>	—	<u>12.4</u>	<u>14.4</u>
(12.835)	(13.002)	(.059)	(.098)	(.504)	(.531)	(.795)		(.488)	(.567)

N		A0		D0		D1		E	
Ref.	Min.	Max.	Min.	Max.	Min.	Max.	Min.	Max.	
<u>100</u>	<u>4.20</u>	<u>4.40</u>	<u>1.50</u>	<u>1.60</u>	<u>1.50</u>	—	<u>1.65</u>	<u>1.85</u>	
(3.937)	(.165)	(.173)	(.059)	(.063)	(.059)		(.065)	(.073)	

F		K0		P0		P1		P2	
Min.	Max.	Min.	Max.	Min.	Max.	Min.	Max.	Min.	Max.
<u>5.45</u>	<u>5.55</u>	<u>1.00</u>	<u>1.20</u>	<u>3.90</u>	<u>4.10</u>	<u>7.90</u>	<u>8.10</u>	<u>1.95</u>	<u>2.05</u>
(.215)	(.219)	(.039)	(.047)	(.154)	(.161)	(.311)	(.319)	(.077)	(.081)

t		W	
Min.	Max.	Min.	Max.
<u>0.25</u>	<u>0.35</u>	<u>11.70</u>	<u>12.30</u>
(.010)	(.014)	(.461)	(.484)

DIMENSIONS:  $\frac{\text{MM}}{\text{(INCHES)}}$

TCS-DL004-250-WH		TCS-DL004-500-WH		TCS-DL004-750-WH	
B0					
Min.	Max.	Min.	Max.	Min.	Max.
<u>2.70</u>	<u>2.90</u>	<u>3.70</u>	<u>3.90</u>	<u>4.70</u>	<u>4.90</u>
(.106)	(.114)	(.146)	(.154)	(.185)	(.193)

REV. 01/25

“TBU” is a registered trademark of Bourns, Inc. in the United States and other countries.

“TCS” is a trademark of Bourns, Inc.

“TISP” is a registered trademark of Bourns Ltd., a Bourns Company, in the United States and other countries, except that “TISP” is a registered trademark of Bourns, Inc. in China.

Specifications are subject to change without notice.

Users should verify actual device performance in their specific applications.

The products described herein and this document are subject to specific legal disclaimers as set forth on the last page of this document, and at [www.bourns.com/docs/legal/disclaimer.pdf](http://www.bourns.com/docs/legal/disclaimer.pdf).

This legal disclaimer applies to purchasers and users of Bourns® products manufactured by or on behalf of Bourns, Inc. and its affiliates (collectively, "Bourns").

Unless otherwise expressly indicated in writing, Bourns® products and data sheets relating thereto are subject to change without notice. Users should check for and obtain the latest relevant information and verify that such information is current and complete before placing orders for Bourns® products.

The characteristics and parameters of a Bourns® product set forth in its data sheet are based on laboratory conditions, and statements regarding the suitability of products for certain types of applications are based on Bourns' knowledge of typical requirements in generic applications. The characteristics and parameters of a Bourns® product in a user application may vary from the data sheet characteristics and parameters due to (i) the combination of the Bourns® product with other components in the user's application, or (ii) the environment of the user application itself. The characteristics and parameters of a Bourns® product also can and do vary in different applications and actual performance may vary over time. Users should always verify the actual performance of the Bourns® product in their specific devices and applications, and make their own independent judgments regarding the amount of additional test margin to design into their device or application to compensate for differences between laboratory and real world conditions.

Unless Bourns has explicitly designated an individual Bourns® product as meeting the requirements of a particular industry standard (e.g., IATF 16949) or a particular qualification (e.g., UL listed or recognized), Bourns is not responsible for any failure of an individual Bourns® product to meet the requirements of such industry standard or particular qualification. Users of Bourns® products are responsible for ensuring compliance with safety-related requirements and standards applicable to their devices or applications.

Bourns® products are not recommended, authorized or intended for use in nuclear, lifesaving, life-critical or life-sustaining applications, nor in any other applications where failure or malfunction may result in personal injury, death, or severe property or environmental damage. Unless expressly and specifically approved in writing by two authorized Bourns representatives on a case-by-case basis, use of any Bourns® products in such unauthorized applications might not be safe and thus is at the user's sole risk. Life-critical applications include devices identified by the U.S. Food and Drug Administration as Class III devices and generally equivalent classifications outside of the United States.

Bourns expressly identifies those Bourns® standard products that are suitable for use in automotive applications on such products' data sheets in the section entitled "Applications." Unless expressly and specifically approved in writing by two authorized Bourns representatives on a case-by-case basis, use of any other Bourns® standard products in an automotive application might not be safe and thus is not recommended, authorized or intended and is at the user's sole risk. If Bourns expressly identifies a sub-category of automotive application in the data sheet for its standard products (such as infotainment or lighting), such identification means that Bourns has reviewed its standard product and has determined that if such Bourns® standard product is considered for potential use in automotive applications, it should only be used in such sub-category of automotive applications. Any reference to Bourns® standard product in the data sheet as compliant with the AEC-Q standard or "automotive grade" does not by itself mean that Bourns has approved such product for use in an automotive application.

Bourns® standard products are not tested to comply with United States Federal Aviation Administration standards generally or any other generally equivalent governmental organization standard applicable to products designed or manufactured for use in aircraft or space applications. Bourns expressly identifies Bourns® standard products that are suitable for use in aircraft or space applications on such products' data sheets in the section entitled "Applications." Unless expressly and specifically approved in writing by two authorized Bourns representatives on a case-by-case basis, use of any other Bourns® standard product in an aircraft or space application might not be safe and thus is not recommended, authorized or intended and is at the user's sole risk.

The use and level of testing applicable to Bourns® custom products shall be negotiated on a case-by-case basis by Bourns and the user for which such Bourns® custom products are specially designed. Absent a written agreement between Bourns and the user regarding the use and level of such testing, the above provisions applicable to Bourns® standard products shall also apply to such Bourns® custom products.

Users shall not sell, transfer, export or re-export any Bourns® products or technology for use in activities which involve the design, development, production, use or stockpiling of nuclear, chemical or biological weapons or missiles, nor shall they use Bourns® products or technology in any facility which engages in activities relating to such devices. The foregoing restrictions apply to all uses and applications that violate national or international prohibitions, including embargos or international regulations. Further, Bourns® products and Bourns technology and technical data may not under any circumstance be exported or re-exported to countries subject to international sanctions or embargoes. Bourns® products may not, without prior authorization from Bourns and/or the U.S. Government, be resold, transferred, or re-exported to any party not eligible to receive U.S. commodities, software, and technical data.

To the maximum extent permitted by applicable law, Bourns disclaims (i) any and all liability for special, punitive, consequential, incidental or indirect damages or lost revenues or lost profits, and (ii) any and all implied warranties, including implied warranties of fitness for particular purpose, non-infringement and merchantability.

*For your convenience, copies of this Legal Disclaimer Notice with German, Spanish, Japanese, Traditional Chinese and Simplified Chinese bilingual versions are available at:*

*Web Page:* <http://www.bourns.com/legal/disclaimers-terms-and-policies>

*PDF:* <http://www.bourns.com/docs/Legal/disclaimer.pdf>