



**\*RoHS COMPLIANT  
&  
HALOGEN FREE\*\***

### Features

- Standard 2920 footprint
- Swift Time-to-Trip (TTT) for safeguarding against overcurrent events
- Excellent solderability with ENIG terminal
- Symmetric designs and low profile
- High power rating and high voltage
- Agency recognition:  
- TÜV certifications cover IEC 62319-1, IEC 60738-1, and IEC 60730-1:2013, encompassing clause 15, clause 17, and Annex J.
- RoHS compliant\* and halogen free\*\*

### Applications

- E-mobility
- Battery Management Systems (BMS)
- Autonomous Mobile Robots (AMRs)
- Data centers
- Industrial drone and UAV platforms
- Smart homes
- USB and PoE

### Sustainability

- Small size reduces material use
- Eco-logistics-friendly packing
- Energy-saving low power design
- ISO 14001, low impact energy
- Responsibly sourced and produced

### Product Overview

The Bourns® MF-LSMF Series PTC Resettable Fuses provide compact 2920-size overcurrent protection with fast trip performance, high voltage capability, and long-term reliability. Their low-profile, symmetric design saves board space, while ENIG terminals ensure excellent solderability and robust assembly.

AEC-Q200 compliance (select models) and wide operating temperature support make the MF-LSMF Series ideal for e-mobility, battery management systems, robotics, industrial equipment, and smart-device applications.

### Electrical Characteristics

Model	V <sub>max</sub>	I <sub>max</sub>	I <sub>hold</sub>	I <sub>trip</sub>	Resistance		Max. Time to Trip		Tripped Power Dissipation	Agency Recognition		AEC-Q200 Compliant
			at 23 °C		at 23 °C Ohms		at 23 °C		at 23 °C Watts	cUL	TÜV	
			Amps		R <sub>min</sub>	R <sub>1max</sub> <sup>1</sup>	Amps	Seconds	Typ.	E174545	R50256634	
MF-LSMF030X	60	40	0.30	0.6	0.9	4.8	1.5	3	1.5	✓	✓	✓
<b>NEW!</b> MF-LSMF035/72X	72	20	0.35	0.7	0.3	2.6	2.5	5	1.5	✓	✓	✓
MF-LSMF050X	60	40	0.50	1.0	0.2	1.5	2.5	4	1.5	✓	✓	✓
<b>NEW!</b> MF-LSMF050/72X	72	20	0.50	1.0	0.2	1.5	2.5	5	1.5	✓	✓	✓
MF-LSMF075X	30	40	0.75	1.5	0.15	1.0	8.0	0.3	1.5	✓	✓	✓
MF-LSMF075/60X	60	40	0.75	1.5	0.15	1.0	8.0	0.3	1.5	✓	✓	✓
<b>NEW!</b> MF-LSMF075/72X	72	20	0.75	1.5	0.15	1.0	8.0	0.3	1.5	✓	✓	✓
MF-LSMF110X	33	40	1.10	2.2	0.07	0.41	8.0	0.5	1.5	✓	✓	✓
MF-LSMF110/60X	60	40	1.10	2.2	0.07	0.41	8.0	0.5	2.0	✓	✓	✓
MF-LSMF125X	15	40	1.25	2.5	0.05	0.25	8.0	2	1.5	✓	✓	✓
MF-LSMF125/33X	33	40	1.25	2.5	0.055	0.25	8.0	2	1.5	✓	✓	✓
MF-LSMF150X	15	40	1.50	3.0	0.050	0.23	8.0	2	1.5	✓	✓	✓
MF-LSMF150/33X	33	40	1.50	3.0	0.050	0.23	8.0	2	1.5	✓	✓	✓
MF-LSMF185X	15	40	1.85	3.7	0.045	0.15	8.0	2.5	1.5	✓	✓	✓
MF-LSMF185/24X	24	40	1.85	3.7	0.045	0.15	8.0	2.5	1.5	✓	✓	✓
MF-LSMF185/33X	33	40	1.85	3.7	0.045	0.15	8.0	2.5	1.5	✓	✓	✓

<sup>1</sup>R<sub>1max</sub>: measured one hour post reflow.

Continued on page 2

\* RoHS Directive 2015/863, Mar 31, 2015 and Annex.

\*\* Bourns considers a product to be "halogen free" if (a) the Bromine (Br) content is 900 ppm or less; (b) the Chlorine (Cl) content is 900 ppm or less; and (c) the total Bromine (Br) and Chlorine (Cl) content is 1500 ppm or less.

Specifications are subject to change without notice.

Users should verify actual device performance in their specific applications. The products described herein and this document are subject to specific legal disclaimers as set forth on the last page of this document, and at [www.bourns.com/docs/legal/disclaimer.pdf](http://www.bourns.com/docs/legal/disclaimer.pdf).

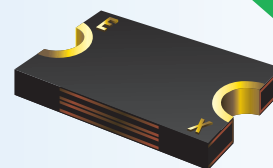
**Electrical Characteristics (Continued)**

Model	V <sub>max</sub>	I <sub>max</sub>	I <sub>hold</sub>	I <sub>trip</sub>	Resistance		Max. Time to Trip		Tripped Power Dissipation	Agency Recognition		AEC-Q200 Compliant
			at 23 °C		at 23 °C Ohms		at 23 °C		at 23 °C Watts	cUL	TÜV	
			Amps		R <sub>min</sub>	R <sub>1max</sub> <sup>1</sup>	Amps	Seconds	Typ.	E174545	R50256634	
MF-LSMF200X	15	40	2.0	4.0	0.035	0.125	8.0	5	1.5	✓	✓	✓
MF-LSMF200/24X	24	40	2.0	4.0	0.035	0.125	8.0	5	1.5	✓	✓	✓
<b>NEW!</b> MF-LSMF200/33X	33	40	2.0	4.0	0.025	0.120	8.0	5	1.5	✓	✓	✓
MF-LSMF260X	24	40	2.6	5.2	0.020	0.075	8.0	5	1.5	✓	✓	✓
MF-LSMF260/6X	6	40	2.6	5.0	0.020	0.075	8.0	10	1.5	✓	✓	
MF-LSMF260/16X	16	40	2.6	5.2	0.020	0.075	8.0	5	1.5	✓	✓	✓
<b>NEW!</b> MF-LSMF260/33X	33	40	2.6	5.2	0.017	0.075	8.0	15	1.5	✓	✓	✓
MF-LSMF300X	6	40	3.0	5.0	0.015	0.048	8.0	15	1.5	✓	✓	
MF-LSMF300/16X	16	40	3.0	5.0	0.015	0.048	8.0	15	1.5	✓	✓	✓
MF-LSMF300/24X	24	40	3.0	5.2	0.015	0.075	8.0	15	1.5	✓	✓	✓
MF-LSMF330X	6	40	3.3	5.5	0.010	0.055	8.0	15	2.0	✓	✓	
MF-LSMF330/12X	12	40	3.3	5.5	0.010	0.055	8.0	15	2.0	✓	✓	
MF-LSMF330/16X	16	40	3.3	5.5	0.010	0.055	8.0	15	2.0	✓	✓	✓
MF-LSMF330/24X	24	40	3.3	5.5	0.010	0.055	8.0	15	2.0	✓	✓	✓
MF-LSMF400/16X	16	40	4.0	8.0	0.005	0.040	20	4	1.5	✓	✓	✓
<b>NEW!</b> MF-LSMF450/16X	16	40	4.5	9.0	0.005	0.035	20	5	1.5	✓	✓	✓
MF-LSMF500/16X	16	40	5.0	10.0	0.005	0.025	20	5	1.5	✓	✓	✓
<b>NEW!</b> MF-LSMF550/16X	16	40	5.5	11.0	0.005	0.023	25	5	2.0	✓	✓	✓
<b>NEW!</b> MF-LSMF600/12X	12	50	6.0	12.0	0.004	0.020	30	2	2.0	✓	✓	
<b>NEW!</b> MF-LSMF600/16X	16	40	6.0	12.0	0.004	0.020	30	2	2.2	✓	✓	✓
<b>NEW!</b> MF-LSMF700/12X	12	50	7.0	14.0	0.002	0.018	35	2	2.0	✓	✓	

<sup>1</sup>R<sub>1max</sub>: measured one hour post reflow.

**Environmental Characteristics**

Item	Condition	Criteria
Operating Temperature	-40 °C to +85 °C	
Recommended Storage	+40 °C max. / 70 % R.H. max.	
Passive Aging	+85 °C, 1000 hours	±5 % typical resistance change
Humidity Aging	+85 °C, 85 % R.H. 1000 hours	±5 % typical resistance change
Thermal Shock	-40 °C to +85 °C, 20 times	±10 % typical resistance change
Solvent Resistance	MIL-STD-202, Method 215	No change (marking still legible)
Vibration	MIL-STD-883C, Method 2007.1 Condition A	No change (R <sub>min</sub> < R < R <sub>1max</sub> )
Moisture Sensitivity Level (MSL)	<a href="#">See Note</a>	
ESD Classification	Class 6 (per AEC-Q200-2, HBM)	

**How to Order**
**MF - LSMF 185 / 33 X - 2**

Multifuse® Product Designator \_\_\_\_\_

Series \_\_\_\_\_

LSMF = 2920 Surface Mount Component

Hold Current (I<sub>hold</sub>) Indicator \_\_\_\_\_

030-700 (0.3 Amps - 7.0 Amps)

Voltage Options \_\_\_\_\_

6 = 6 Voltage Rated    30 = 30 Voltage Rated  
 12 = 12 Voltage Rated    33 = 33 Voltage Rated  
 15 = 15 Voltage Rated    60 = 60 Voltage Rated  
 16 = 16 Voltage Rated    72 = 72 Voltage Rated  
 24 = 24 Voltage Rated

Multifuse® Design Specific Code \_\_\_\_\_

X = Multifuse® freeXpansion™ Design

Packaging \_\_\_\_\_

-2 = Tape and Reel Packaged per EIA-481

Specifications are subject to change without notice. Users should verify actual device performance in their specific applications.

 The products described herein and this document are subject to specific legal disclaimers as set forth on the last page of this document, and at [www.bourns.com/docs/legal/disclaimer.pdf](http://www.bourns.com/docs/legal/disclaimer.pdf).

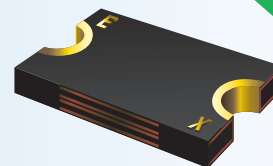

### Test Procedures and Requirements

Item	Test Conditions	Accept/Reject Criteria
Visual/Mechanical	Verify dimensions and materials	Per MF physical description
Resistance	In still air @ 23 °C	$R_{min} \leq R \leq R_{max}$
Time to Trip	At specified current, $V_{max}$ , 23 °C, still air	$T \leq$ max. time to trip (seconds)
Hold Current	30 min. at $I_{hold}$ , still air	No trip
Trip Cycle Life	$V_{max}$ , $I_{max}$ , 100 cycles	No arcing or burning
Trip Endurance	$V_{max}$ , 48 hours	No arcing or burning
Solderability	245 °C $\pm$ 5 °C, 5 seconds	95 % min. coverage

### Thermal Derating Chart - $I_{hold}$ (Amps)

Model	Ambient Operating Temperature								
	-40 °C	-20 °C	0 °C	23 °C	40 °C	50 °C	60 °C	70 °C	85 °C
MF-LSMF030X	0.44	0.40	0.35	0.30	0.25	0.23	0.20	0.17	0.10
MF-LSMF035/72X	0.51	0.47	0.41	0.35	0.29	0.27	0.23	0.20	0.12
MF-LSMF050X	0.73	0.67	0.59	0.50	0.42	0.38	0.33	0.29	0.23
MF-LSMF050/72X	0.73	0.67	0.59	0.50	0.42	0.38	0.33	0.29	0.23
MF-LSMF075X	1.10	1.01	0.89	0.75	0.63	0.56	0.50	0.44	0.34
MF-LSMF075/60X	1.10	1.01	0.89	0.75	0.63	0.56	0.50	0.44	0.30
MF-LSMF075/72X	1.10	1.01	0.89	0.75	0.63	0.56	0.50	0.44	0.30
MF-LSMF110X	1.61	1.47	1.30	1.10	0.92	0.83	0.73	0.64	0.50
MF-LSMF110/60X	1.61	1.47	1.30	1.10	0.92	0.83	0.73	0.64	0.50
MF-LSMF125X	1.83	1.68	1.48	1.25	1.05	0.94	0.83	0.73	0.56
MF-LSMF125/33X	1.83	1.68	1.48	1.25	1.05	0.94	0.83	0.73	0.56
MF-LSMF150X	2.19	2.01	1.77	1.50	1.26	1.13	0.99	0.87	0.68
MF-LSMF150/33X	2.19	2.01	1.77	1.50	1.26	1.13	0.99	0.87	0.68
MF-LSMF185X	2.70	2.48	2.18	1.85	1.55	1.39	1.22	1.07	0.83
MF-LSMF185/24X	2.80	2.47	2.17	1.85	1.54	1.39	1.22	1.07	0.85
MF-LSMF185/33X	2.80	2.47	2.17	1.85	1.54	1.39	1.22	1.07	0.85
MF-LSMF200X	2.92	2.68	2.36	2.00	1.68	1.50	1.32	1.16	0.90
MF-LSMF200/24X	2.92	2.68	2.36	2.00	1.68	1.50	1.32	1.16	0.90
MF-LSMF200/33X	2.92	2.68	2.36	2.00	1.68	1.50	1.32	1.16	0.90
MF-LSMF260X	3.75	3.35	3.00	2.60	2.35	2.15	2.05	1.80	1.30
MF-LSMF260/6X	3.80	3.48	3.07	2.60	2.18	1.95	1.72	1.51	1.17
MF-LSMF260/16X	3.75	3.35	3.00	2.60	2.35	2.15	2.05	1.80	1.30
MF-LSMF260/33X	3.80	3.48	3.07	2.60	2.18	1.95	1.72	1.51	1.17
MF-LSMF300X	4.53	4.02	3.51	3.00	2.52	2.26	1.99	1.75	1.34
MF-LSMF300/16X	4.38	4.02	3.54	3.00	2.52	2.25	1.98	1.74	1.35
MF-LSMF300/24X	4.00	3.55	3.20	3.00	2.50	2.25	2.15	1.85	1.50
MF-LSMF330X	4.82	4.42	3.89	3.30	2.77	2.48	2.18	1.91	1.49
MF-LSMF330/12X	4.82	4.42	3.89	3.30	2.77	2.48	2.18	1.91	1.49
MF-LSMF330/16X	4.82	4.42	3.89	3.30	2.77	2.48	2.18	1.91	1.49
MF-LSMF330/24X	4.82	4.42	3.89	3.30	2.77	2.48	2.18	1.91	1.49
MF-LSMF400/16X	5.84	5.36	4.72	4.00	3.36	3.00	2.64	2.32	1.80
MF-LSMF450/16X	6.57	6.03	5.31	4.50	3.78	3.38	2.97	2.61	2.03
MF-LSMF500/16X	7.30	6.70	5.90	5.00	4.20	3.75	3.30	2.90	2.25
MF-LSMF550/16X	8.03	7.37	6.49	5.50	4.62	4.13	3.63	3.19	2.48
MF-LSMF600/12X	8.76	8.04	7.08	6.00	5.04	4.50	3.96	3.48	2.70
MF-LSMF600/16X	8.76	8.04	7.08	6.00	5.04	4.50	3.96	3.48	2.70
MF-LSMF700/12X	10.22	9.38	8.26	7.00	5.88	5.25	4.62	4.06	3.15

Specifications are subject to change without notice.  
Users should verify actual device performance in their specific applications.

The products described herein and this document are subject to specific legal disclaimers as set forth on the last page of this document, and at [www.bourns.com/docs/legal/disclaimer.pdf](http://www.bourns.com/docs/legal/disclaimer.pdf).

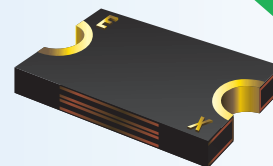

Product Dimensions										
Model	A		B		C		D		E	
	Min.	Max.	Min.	Max.	Min.	Max.	Min.	Max.	Min.	Max.
MF-LSMF030X	$\frac{6.73}{(0.265)}$	$\frac{7.98}{(0.314)}$	$\frac{4.80}{(0.189)}$	$\frac{5.44}{(0.214)}$	$\frac{0.75}{(0.030)}$	$\frac{1.25}{(0.049)}$				
MF-LSMF035/72X	$\frac{6.73}{(0.265)}$	$\frac{7.98}{(0.314)}$	$\frac{4.80}{(0.189)}$	$\frac{5.44}{(0.214)}$	$\frac{0.75}{(0.030)}$	$\frac{1.25}{(0.049)}$				
MF-LSMF050X	$\frac{6.73}{(0.265)}$	$\frac{7.98}{(0.314)}$	$\frac{4.80}{(0.189)}$	$\frac{5.44}{(0.214)}$	$\frac{0.75}{(0.030)}$	$\frac{1.25}{(0.049)}$				
MF-LSMF050X/72X	$\frac{6.73}{(0.265)}$	$\frac{7.98}{(0.314)}$	$\frac{4.80}{(0.189)}$	$\frac{5.44}{(0.214)}$	$\frac{0.75}{(0.030)}$	$\frac{1.25}{(0.049)}$				
MF-LSMF075X	$\frac{6.73}{(0.265)}$	$\frac{7.98}{(0.314)}$	$\frac{4.80}{(0.189)}$	$\frac{5.44}{(0.214)}$	$\frac{0.35}{(0.014)}$	$\frac{0.85}{(0.033)}$				
MF-LSMF075/60X	$\frac{6.73}{(0.265)}$	$\frac{7.98}{(0.314)}$	$\frac{4.80}{(0.189)}$	$\frac{5.44}{(0.214)}$	$\frac{0.75}{(0.030)}$	$\frac{1.70}{(0.067)}$				
MF-LSMF075/72X	$\frac{6.73}{(0.265)}$	$\frac{7.98}{(0.314)}$	$\frac{4.80}{(0.189)}$	$\frac{5.44}{(0.214)}$	$\frac{0.75}{(0.030)}$	$\frac{1.70}{(0.067)}$				
MF-LSMF110X	$\frac{6.73}{(0.265)}$	$\frac{7.98}{(0.314)}$	$\frac{4.80}{(0.189)}$	$\frac{5.44}{(0.214)}$	$\frac{0.35}{(0.014)}$	$\frac{0.85}{(0.033)}$				
MF-LSMF110/60X	$\frac{6.73}{(0.265)}$	$\frac{7.98}{(0.314)}$	$\frac{4.80}{(0.189)}$	$\frac{5.44}{(0.214)}$	$\frac{0.75}{(0.030)}$	$\frac{1.70}{(0.067)}$				
MF-LSMF125X	$\frac{6.73}{(0.265)}$	$\frac{7.98}{(0.314)}$	$\frac{4.80}{(0.189)}$	$\frac{5.44}{(0.214)}$	$\frac{0.35}{(0.014)}$	$\frac{0.85}{(0.033)}$				
MF-LSMF125/33X	$\frac{6.73}{(0.265)}$	$\frac{7.98}{(0.314)}$	$\frac{4.80}{(0.189)}$	$\frac{5.44}{(0.214)}$	$\frac{0.75}{(0.030)}$	$\frac{1.60}{(0.063)}$				
MF-LSMF150X	$\frac{6.73}{(0.265)}$	$\frac{7.98}{(0.314)}$	$\frac{4.80}{(0.189)}$	$\frac{5.44}{(0.214)}$	$\frac{0.35}{(0.014)}$	$\frac{0.85}{(0.033)}$				
MF-LSMF150/33X	$\frac{6.73}{(0.265)}$	$\frac{7.98}{(0.314)}$	$\frac{4.80}{(0.189)}$	$\frac{5.44}{(0.214)}$	$\frac{0.75}{(0.030)}$	$\frac{1.60}{(0.063)}$	$\frac{0.30}{(0.012)}$	$\frac{2.50}{(0.098)}$	$\frac{0.25}{(0.010)}$	$\frac{2.00}{(0.079)}$
MF-LSMF185X	$\frac{6.73}{(0.265)}$	$\frac{7.98}{(0.314)}$	$\frac{4.80}{(0.189)}$	$\frac{5.44}{(0.214)}$	$\frac{0.35}{(0.014)}$	$\frac{0.85}{(0.033)}$				
MF-LSMF185/24X	$\frac{6.73}{(0.265)}$	$\frac{7.98}{(0.314)}$	$\frac{4.80}{(0.189)}$	$\frac{5.44}{(0.214)}$	$\frac{0.75}{(0.030)}$	$\frac{1.60}{(0.063)}$				
MF-LSMF185/33X	$\frac{6.73}{(0.265)}$	$\frac{7.98}{(0.314)}$	$\frac{4.80}{(0.189)}$	$\frac{5.44}{(0.214)}$	$\frac{0.75}{(0.030)}$	$\frac{1.60}{(0.063)}$				
MF-LSMF200X	$\frac{6.73}{(0.265)}$	$\frac{7.98}{(0.314)}$	$\frac{4.80}{(0.189)}$	$\frac{5.44}{(0.214)}$	$\frac{0.75}{(0.030)}$	$\frac{1.60}{(0.063)}$				
MF-LSMF200/24X	$\frac{6.73}{(0.265)}$	$\frac{7.98}{(0.314)}$	$\frac{4.80}{(0.189)}$	$\frac{5.44}{(0.214)}$	$\frac{0.75}{(0.030)}$	$\frac{1.60}{(0.063)}$				
MF-LSMF200/33X	$\frac{6.73}{(0.265)}$	$\frac{7.98}{(0.314)}$	$\frac{4.80}{(0.189)}$	$\frac{5.44}{(0.214)}$	$\frac{0.75}{(0.030)}$	$\frac{1.60}{(0.063)}$				
MF-LSMF260X	$\frac{6.73}{(0.265)}$	$\frac{7.98}{(0.314)}$	$\frac{4.80}{(0.189)}$	$\frac{5.44}{(0.214)}$	$\frac{0.75}{(0.030)}$	$\frac{1.60}{(0.063)}$				
MF-LSMF260/6X	$\frac{6.73}{(0.265)}$	$\frac{7.98}{(0.314)}$	$\frac{4.80}{(0.189)}$	$\frac{5.44}{(0.214)}$	$\frac{0.35}{(0.014)}$	$\frac{0.85}{(0.033)}$				
MF-LSMF260/16X	$\frac{6.73}{(0.265)}$	$\frac{7.98}{(0.314)}$	$\frac{4.80}{(0.189)}$	$\frac{5.44}{(0.214)}$	$\frac{0.75}{(0.030)}$	$\frac{1.60}{(0.063)}$				
MF-LSMF260/33X	$\frac{6.73}{(0.265)}$	$\frac{7.98}{(0.314)}$	$\frac{4.80}{(0.189)}$	$\frac{5.44}{(0.214)}$	$\frac{0.75}{(0.030)}$	$\frac{1.60}{(0.063)}$				
MF-LSMF300X	$\frac{6.73}{(0.265)}$	$\frac{7.98}{(0.314)}$	$\frac{4.80}{(0.189)}$	$\frac{5.44}{(0.214)}$	$\frac{0.35}{(0.014)}$	$\frac{0.85}{(0.033)}$				
MF-LSMF300/16X	$\frac{6.73}{(0.265)}$	$\frac{7.98}{(0.314)}$	$\frac{4.80}{(0.189)}$	$\frac{5.44}{(0.214)}$	$\frac{0.75}{(0.030)}$	$\frac{1.25}{(0.049)}$				

*Continued on page 5*

Specifications are subject to change without notice.  
Users should verify actual device performance in their specific applications.

The products described herein and this document are subject to specific legal disclaimers as set forth on the last page of this document, and at [www.bourns.com/docs/legal/disclaimer.pdf](http://www.bourns.com/docs/legal/disclaimer.pdf).

## MF-LSMF SERIES

Multifuse® PPTC Resettable Fuses

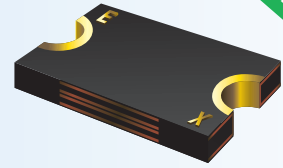

**\*RoHS COMPLIANT & HALOGEN FREE\*\***

Product Dimensions (Continued)										
Model	A		B		C		D		E	
	Min.	Max.	Min.	Max.	Min.	Max.	Min.	Max.	Min.	Max.
MF-LSMF300/24X	6.73 (0.265)	7.98 (0.314)	4.80 (0.189)	5.44 (0.214)	0.75 (0.030)	1.60 (0.063)	0.30 (0.012)	2.50 (0.098)	0.25 (.010)	2.00 (.079)
MF-LSMF330X	6.73 (0.265)	7.98 (0.314)	4.80 (0.189)	5.44 (0.214)	0.35 (0.014)	0.85 (0.033)				
MF-LSMF330/12X	6.73 (0.265)	7.98 (0.314)	4.80 (0.189)	5.44 (0.214)	0.75 (0.030)	1.60 (0.063)				
MF-LSMF330/16X	6.73 (0.265)	7.98 (0.314)	4.80 (0.189)	5.44 (0.214)	0.75 (0.030)	1.60 (0.063)				
MF-LSMF330/24X	6.73 (0.265)	7.98 (0.314)	4.80 (0.189)	5.44 (0.214)	0.75 (0.030)	1.60 (0.063)				
MF-LSMF400/16X	6.73 (0.265)	7.98 (0.314)	4.80 (0.189)	5.44 (0.214)	0.75 (0.030)	1.60 (0.063)				
MF-LSMF450/16X	6.73 (0.265)	7.98 (0.314)	4.80 (0.189)	5.44 (0.214)	0.75 (0.030)	1.60 (0.063)				
MF-LSMF500/16X	6.73 (0.265)	7.98 (0.314)	4.80 (0.189)	5.44 (0.214)	0.75 (0.030)	1.60 (0.063)				
MF-LSMF550/16X	6.73 (0.265)	7.98 (0.314)	4.80 (0.189)	5.44 (0.214)	0.75 (0.030)	1.60 (0.063)				
MF-LSMF600/12X	6.73 (0.265)	7.98 (0.314)	4.80 (0.189)	5.44 (0.214)	0.75 (0.030)	1.60 (0.063)				
MF-LSMF600/16X	6.73 (0.265)	7.98 (0.314)	4.80 (0.189)	5.44 (0.214)	0.75 (0.030)	1.60 (0.063)				
MF-LSMF700/12X	6.73 (0.265)	7.98 (0.314)	4.80 (0.189)	5.44 (0.214)	0.75 (0.030)	2.00 (0.079)				

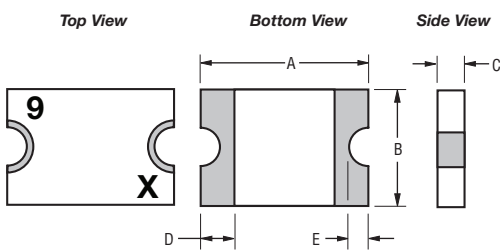

**Terminal material:**  
Electroless nickel under immersion gold (ENIG)

**Recommended Pad Layout**

DIMENSIONS:  $\frac{\text{MM}}{\text{(INCHES)}}$

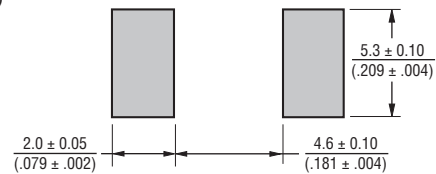

### Typical Time to Trip at 23 °C

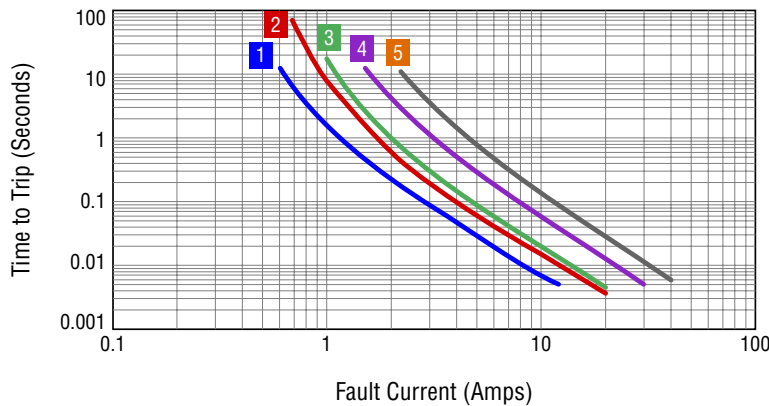

- 1** MF-LSMF030X
- 2** MF-LSMF035/72X
- 3** MF-LSMF050X, MF-LSMF050/72X
- 4** MF-LSMF075/60X, MF-LSMF075/72X
- 5** MF-LSMF110/60X

Specifications are subject to change without notice. Users should verify actual device performance in their specific applications.

The products described herein and this document are subject to specific legal disclaimers as set forth on the last page of this document, and at [www.bourns.com/docs/legal/disclaimer.pdf](http://www.bourns.com/docs/legal/disclaimer.pdf).

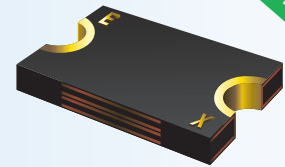

**\*RoHS COMPLIANT  
&  
HALOGEN FREE\*\***

**Typical Time to Trip at 23 °C (Continued)**

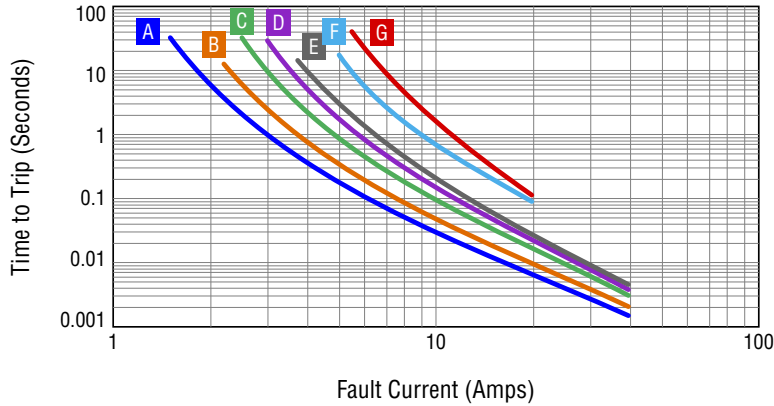

- A** MF-LSMF075X
- B** MF-LSMF110X
- C** MF-LSMF125X
- D** MF-LSMF150X
- E** MF-LSMF185X
- F** MF-LSMF260/6X
- G** MF-LSMF330X

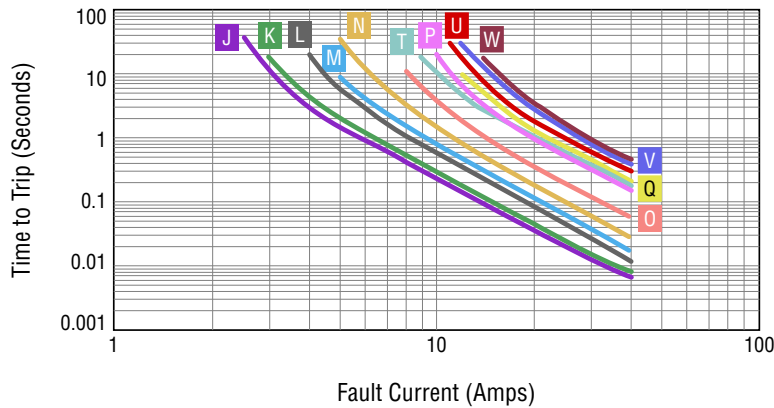

- J** MF-LSMF125/33X
- K** MF-LSMF150/33X
- L** MF-LSMF200X, MF-LSMF200/24X,  
MF-LSMF200/33X
- M** MF-LSMF260X, MF-LSMF260/16X,  
MF-LSMF260/33X
- N** MF-LSMF300/16X
- O** MF-LSMF400/16X
- T** MF-LSMF450/16X
- P** MF-LSMF500/16X
- U** MF-LSMF550/16X
- Q** MF-LSMF600/12X
- V** MF-LSMF600/16X
- W** MF-LSMF700/12X

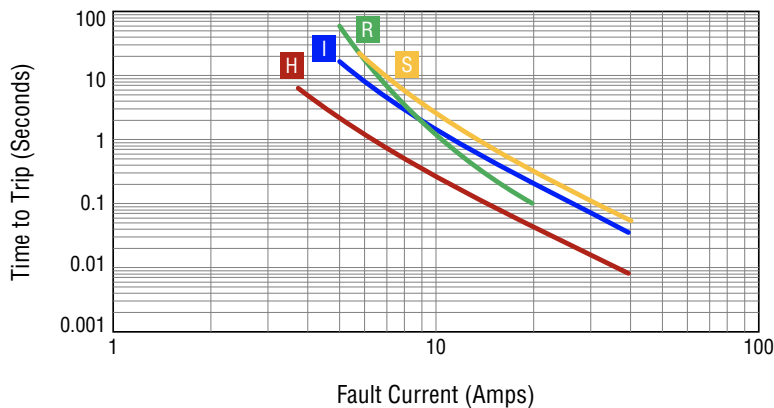

- H** MF-LSMF185/24X, MF-LSMF185/33X
- I** MF-LSMF300/24X
- R** MF-LSMF300X
- S** MF-LSMF330/12X, MF-LSMF330/16X,  
MF-LSMF330/24X

The Time to Trip curves represent typical performance of a device in a simulated application environment. Actual performance in specific customer applications may differ from these values due to the influence of other variables.

Specifications are subject to change without notice. Users should verify actual device performance in their specific applications.

The products described herein and this document are subject to specific legal disclaimers as set forth on the last page of this document, and at [www.bourns.com/docs/legal/disclaimer.pdf](http://www.bourns.com/docs/legal/disclaimer.pdf).

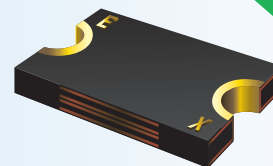

**\*RoHS COMPLIANT & HALOGEN FREE\*\***

**Typical Part Marking**

Represents total content. Layout may vary.



**PART IDENTIFICATION EXAMPLES:**

MF-LSMF030X = 3	MF-LSMF110X = 6	MF-LSMF200/33X = A	MF-LSMF330/16X = Q
MF-LSMF035/72X = 2	MF-LSMF110/60X = 6	MF-LSMF260X = E	MF-LSMF330/24X = Q
MF-LSMF050X = 4	MF-LSMF125X = 7	MF-LSMF260/6X = P	MF-LSMF400/16X = K
MF-LSMF050/72X = 4	MF-LSMF125/33X = L	MF-LSMF260/16X = E	MF-LSMF450/16X = C
MF-LSMF075X = 5	MF-LSMF150X = M	MF-LSMF260/33X = E	MF-LSMF500/16X = S
MF-LSMF075X /60X = 5	MF-LSMF150/33X = 8	MF-LSMF300X = F	MF-LSMF550/16X = D
MF-LSMF075X /72X = 5	MF-LSMF185X = N	MF-LSMF300/16X = H	MF-LSMF600/12X = T
	MF-LSMF185/24X = 9	MF-LSMF300/24X = J	MF-LSMF600/16X = Y
<b>BI-WEEKLY DATE CODE:</b>	MF-LSMF185/33X = 9	MF-LSMF330X = X	MF-LSMF700/12X = U
WEEKS 47-48 = X	MF-LSMF200X = A	MF-LSMF330/12X = Q	
	MF-LSMF200/24X = A		

**Solder Reflow Recommendations**

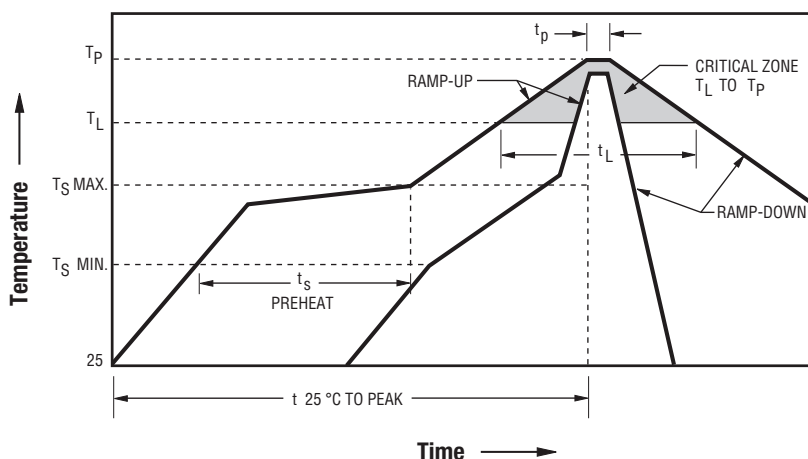

**Notes:**

- MF-LSMF models are intended for reflow soldering (including but not limited to heating plate, hot air, IR, nitrogen, and vapor phase).
- Wave soldering is permissible only if the device is on the top of the PCB, opposite the heat source.
- Hand soldering is not recommended for these devices.
- All temperatures refer to the topside of the device, measured on the device body surface.
- If reflow temperatures exceed the recommended profile, devices may not meet the published specifications.
- Compatible with Pb and Pb-free solder reflow profiles.
- Excess solder may cause a short circuit.
- Please refer to the [Multifuse® Polymer PTC Resettable Fuse Soldering Recommendations](#) document for more details.

Profile Feature	Pb-Free Assembly
Average Ramp-Up Rate (Ts <sub>max</sub> to Tp)	3 °C / second max.
PREHEAT:	
Temperature Min. (Ts <sub>min</sub> )	150 °C
Temperature Max. (Ts <sub>max</sub> )	200 °C
Time (Ts <sub>min</sub> to Ts <sub>max</sub> ) (ts)	60~180 seconds
TIME MAINTAINED ABOVE:	
Temperature (T <sub>L</sub> )	217 °C
Time (t <sub>L</sub> )	60~150 seconds
Peak Temperature (Tp)	260 °C
Time within 5 °C of Actual Peak Temperature (tp)	20~40 seconds
Ramp-Down Rate	6 °C / second max.
Time 25 °C to Peak Temperature	8 minutes max.

Specifications are subject to change without notice. Users should verify actual device performance in their specific applications.

The products described herein and this document are subject to specific legal disclaimers as set forth on the last page of this document, and at [www.bourns.com/docs/legal/disclaimer.pdf](http://www.bourns.com/docs/legal/disclaimer.pdf).

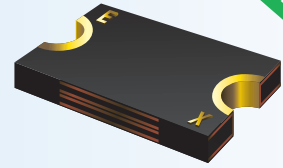

**\*RoHS COMPLIANT  
&  
HALOGEN FREE\*\***

### Tape and Reel Specifications

Tape Dimensions per EIA 481	MF-LSMF075X, MF-LSMF110/X, MF-LSMF125X, MF-LSMF150X, MF-LSMF185X, MF-LSMF260/6X, MF-LSMF300X & MF-LSMF330X	MF-LSMF030X, MF-LSMF035/72X, MF-LSMF050X, MF-LSMF050/72X, MF-LSMF075/60X, MF-LSMF075/72X, MF-LSMF110/60X, MF-LSMF125/33X, MF-LSMF150/33X, MF-LSMF185/24X, MF-LSMF185/33X, MF-LSMF200X, MF-LSMF200/24X, MF-LSMF200/33X, MF-LSMF260X, MF-LSMF260/16X, MF-LSMF260/33X, MF-LSMF300/16X, MF-LSMF300/24X, MF-LSMF330/12X, MF-LSMF330/16X, MF-LSMF330/24X, MF-LSMF400/16X, MF-LSMF450/16X, MF-LSMF500/16X, MF-LSMF550/16X, MF-LSMF600/12X, MF-LSMF600/16X & MF-LSMF700/12X
W	$\frac{16.0 \pm 0.30}{(0.630 \pm 0.012)}$	$\frac{16.0 \pm 0.30}{(0.630 \pm 0.012)}$
P <sub>0</sub>	$\frac{4.0 \pm 0.10}{(0.157 \pm 0.004)}$	$\frac{4.0 \pm 0.10}{(0.157 \pm 0.004)}$
10 P <sub>0</sub>	$\frac{40 \pm 0.20}{(1.575 \pm 0.008)}$	$\frac{40 \pm 0.20}{(1.575 \pm 0.008)}$
P <sub>1</sub>	$\frac{8.0 \pm 0.10}{(0.315 \pm 0.004)}$	$\frac{8.0 \pm 0.10}{(0.315 \pm 0.004)}$
P <sub>2</sub>	$\frac{2.0 \pm 0.10}{(0.079 \pm 0.004)}$	$\frac{2.0 \pm 0.10}{(0.079 \pm 0.004)}$
A <sub>0</sub>	$\frac{5.74 \pm 0.10}{(0.226 \pm 0.004)}$	$\frac{5.70 \pm 0.10}{(0.224 \pm 0.004)}$
B <sub>0</sub>	$\frac{8.02 \pm 0.10}{(0.316 \pm 0.004)}$	$\frac{8.10 \pm 0.10}{(0.319 \pm 0.004)}$
B <sub>1</sub> max.	$\frac{12.1}{(0.476)}$	$\frac{12.1}{(0.476)}$
D <sub>0</sub>	$\frac{1.5 + 0.10/-0}{(0.059 + 0.004/-0)}$	$\frac{1.5 + 0.10/-0}{(0.059 + 0.004/-0)}$
F	$\frac{7.5 \pm 0.10}{(0.295 \pm 0.004)}$	$\frac{7.5 \pm 0.10}{(0.295 \pm 0.004)}$
E <sub>1</sub>	$\frac{1.75 \pm 0.10}{(0.069 \pm 0.004)}$	$\frac{1.75 \pm 0.10}{(0.069 \pm 0.004)}$
E <sub>2</sub> min.	$\frac{14.25}{(0.561)}$	$\frac{14.25}{(0.561)}$
T max.	$\frac{0.6}{(0.024)}$	$\frac{0.6}{(0.024)}$
T <sub>1</sub> max	$\frac{0.1}{(0.004)}$	$\frac{0.1}{(0.004)}$
K <sub>0</sub>	$\frac{0.91 \pm 0.10}{(0.036 \pm 0.004)}$	$\frac{1.70 \pm 0.10}{(0.067 \pm 0.004)}$
Leader min.	$\frac{390}{(15.35)}$	$\frac{390}{(15.35)}$
Trailer min.	$\frac{160}{(6.30)}$	$\frac{160}{(6.30)}$
<b>Reel Dimensions</b>		
A max.	$\frac{331}{(13.03)}$	$\frac{331}{(13.03)}$
N min.	$\frac{50}{(1.97)}$	$\frac{50}{(1.97)}$
W <sub>1</sub>	$\frac{16.4 + 2.0/-0}{(0.646 + 0.079/-0)}$	$\frac{16.4 + 2.0/-0}{(0.646 + 0.079/-0)}$
W <sub>2</sub> max.	$\frac{22.4}{(0.882)}$	$\frac{22.4}{(0.882)}$

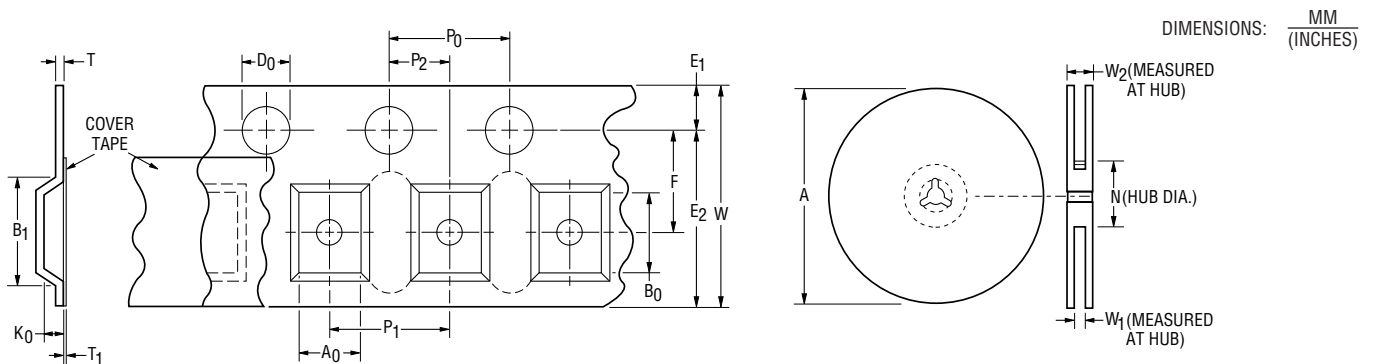

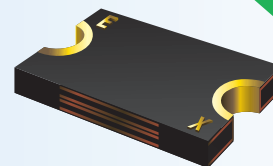

### Packaging Quantity

Model			Unit Quantity (pcs.)	Unit		
MF-LSMF030X	MF-LSMF185/33X	MF-LSMF330/16X	4000	Reel		
MF-LSMF035/72X	MF-LSMF200X	MF-LSMF330/24X				
MF-LSMF050X	MF-LSMF200/33X	MF-LSMF400/16X				
MF-LSMF050/72X	MF-LSMF200/24X	MF-LSMF450/16X				
MF-LSMF075/60X	MF-LSMF260X	MF-LSMF500/16X				
MF-LSMF075/72X	MF-LSMF260/16X	MF-LSMF550/16X				
MF-LSMF110/60X	MF-LSMF260/33X	MF-LSMF600/12X				
MF-LSMF125/33X	MF-LSMF300/16X	MF-LSMF600/16X				
MF-LSMF150/33X	MF-LSMF300/24X	MF-LSMF700/12X				
MF-LSMF185/24X	MF-LSMF330/12X					
MF-LSMF075X	MF-LSMF150X	MF-LSMF300X			6000	Reel
MF-LSMF110X	MF-LSMF185X	MF-LSMF330X				
MF-LSMF125X	MF-LSMF260/6X					

### Contact Information

<a href="http://www.bourns.com">www.bourns.com</a>	Phone	Email
Asia-Pacific	+886-2 2562-4117	<a href="mailto:asiacus@bourns.com">asiacus@bourns.com</a>
Europe	+36 88 885 877	<a href="mailto:eurocus@bourns.com">eurocus@bourns.com</a>
Mexico	+52 614 478 0400	<a href="mailto:mexicus@bourns.com">mexicus@bourns.com</a>
The Americas	+1-951 781-5500	<a href="mailto:americus@bourns.com">americus@bourns.com</a>

MF-LSMF SERIES, REV. R, 05/26

Specifications are subject to change without notice.  
Users should verify actual device performance in their specific applications.

The products described herein and this document are subject to specific legal disclaimers as set forth on the last page of this document, and at [www.bourns.com/docs/legal/disclaimer.pdf](http://www.bourns.com/docs/legal/disclaimer.pdf).

- Users are responsible for independent and adequate evaluation of Bourns® Multifuse® Polymer PTC devices in the user's application, including the PPTC device characteristics stated in the applicable data sheet.
- Polymer PTC devices must not be allowed to operate beyond their stated maximum ratings. Operation in excess of such maximum ratings could result in damage to the PTC device and possibly lead to electrical arcing and/or fire. Circuits with inductance may generate a voltage above the rated voltage of the polymer PTC device and should be thoroughly evaluated within the user's application during the PTC selection and qualification process.
- Polymer PTC devices are intended to protect against adverse effects of temporary overcurrent or overtemperature conditions up to rated limits and are not intended to serve as protective devices where overcurrent or overvoltage conditions are expected to be repetitive or prolonged.
- In normal operation, polymer PTC devices experience thermal expansion under fault conditions. Thus, a polymer PTC device must be protected against mechanical stress, and must be given adequate clearance within the user's application to accommodate such thermal expansion. Rigid potting materials or fixed housings or coverings that do not provide adequate clearance should be thoroughly examined and tested by the user, as they may result in the malfunction of polymer PTC devices if the thermal expansion is inhibited.
- Exposure to lubricants, silicon-based oils, solvents, gels, electrolytes, acids, and other related or similar materials may adversely affect the performance of polymer PTC devices.
- Aggressive solvents may adversely affect the performance of polymer PTC devices. Conformal coating, encapsulating, potting, molding, and sealing materials may contain aggressive solvents including but not limited to xylene and toluene, which are known to cause adverse effects on the performance of polymer PTCs. Such aggressive solvents must be thoroughly cured or baked to ensure their complete removal from polymer PTCs to minimize the possible adverse effect on the device.
- Recommended storage conditions should be followed at all times. Such conditions can be found on the applicable data sheet and on the Multifuse® Polymer PTC Moisture/Reflow Sensitivity Classification (MSL) note: [https://www.bourns.com/docs/RoHS-MSL/msl\\_mf.pdf](https://www.bourns.com/docs/RoHS-MSL/msl_mf.pdf)



**CALIFORNIA WARNING:** Can expose you to lead, a carcinogen and reproductive toxicant.

See [www.P65Warnings.ca.gov](http://www.P65Warnings.ca.gov)

This legal disclaimer applies to purchasers and users of Bourns® products manufactured by or on behalf of Bourns, Inc. and its affiliates (collectively, "Bourns").

Unless otherwise expressly indicated in writing, Bourns® products and data sheets relating thereto are subject to change without notice. Users should check for and obtain the latest relevant information and verify that such information is current and complete before placing orders for Bourns® products.

The characteristics and parameters of a Bourns® product set forth in its data sheet are based on laboratory conditions, and statements regarding the suitability of products for certain "typical" applications are based on Bourns' knowledge of typical requirements in generic applications. Bourns assumes that "typical" applications include failsafe/backup features to address critical risks to users and are designed to allow rework of Bourns® product to avoid scrap of a device solely due to malfunctioning Bourns® product. The characteristics and parameters of a Bourns® product in a user application may vary from the data sheet characteristics and parameters due to (i) the combination of the Bourns® product with other components in the user's application, or (ii) the environment of the user application itself. The characteristics and parameters of a Bourns® product also can and do vary in different applications and actual performance may vary over time. Thus, users should always verify the actual performance of the Bourns® product in their specific devices and applications and make their own independent judgments regarding the suitability of Bourns® product and the amount of additional test margin to design into their device or application to compensate for differences between laboratory and real-world conditions.

Unless Bourns has explicitly designated an individual Bourns® product as meeting the requirements of a particular industry standard (e.g., IATF 16949) or a particular qualification (e.g., UL listed or recognized), Bourns is not responsible for any failure of an individual Bourns® product to meet the requirements of such industry standard or particular qualification even if such industry standard or qualification is a "state of art". Users of Bourns® products are responsible for ensuring compliance with safety-related requirements and standards applicable to their devices or applications.

Bourns® products are not recommended, authorized or intended for use in applications where failure or malfunction may result in personal injury, death, or severe property or environmental damage, such as without limitation nuclear, life-critical medical and certain automotive and aviation applications. Except as set forth in the bullet points below or unless expressly and specifically approved in writing on a case-by-case basis by an authorized Bourns' representative, use of any Bourns® products in such unauthorized high-risk applications is at the user's sole risk.

- Bourns considers implantable/invasive devices and devices/procedures designed as life-supporting or life-sustaining by the U.S. Food and Drug Administration or equivalent organizations outside of the United States as "life-critical" medical applications. Bourns expressly identifies those Bourns® standard products that are suitable for use in typical medical applications that are not life-critical in its publication entitled "Bourns Medical Grade Component Guide."
- Bourns expressly identifies those Bourns® standard products that are suitable for use in typical automotive applications associated with any Automate Safety Integrity Level (ASIL) in its publication entitled "Bourns Automotive Grade Component Guide." Bourns' designation of Bourns® product as compliant with the AEC-Q standard does not by itself mean that Bourns has approved such product for use in an automotive application.
- Bourns expressly identifies Bourns® standard products that are suitable for use in the typical aviation applications/systems requiring System Design Assurance Level (RTCA DO-254 DAL) of C, D or E in its publication entitled "Bourns Civilian Aerospace/Aviation Grade Component Guide." Bourns does not test its products for compliance with United States Federal Aviation Administration standards or any other generally equivalent governmental organization standard applicable to products designed or manufactured for use in aviation applications. Use of Bourns® standard components in aviation applications associated with RTCA DO-254 DAL A or B without proper approval noted above shall be at the user's sole risk.
- Bourns will review and authorize on a case-by-case basis the use of Bourns® standard products which are at least AEC-Q compliant in space-related civil applications (rockets, satellites) with a negotiated cross-waiver and indemnity agreement.

The use and level of testing applicable to Bourns® custom products shall be negotiated on a case-by-case basis by Bourns and the user for which such Bourns® custom products are specially designed. Absent a written agreement between Bourns and the user regarding the use and level of such testing, the above provisions applicable to Bourns® standard products shall also apply to such Bourns® custom products.

Use of Bourns® products or Bourns' technology in military/defense applications must be reviewed with Bourns for compliance with applicable export control laws and embargoes. Users shall not sell, transfer, export or re-export (which includes transfers within a country) any Bourns® products or technology or technical data for use in activities which involve the design, development, production, use or stockpiling of nuclear, chemical or biological weapons or missiles, nor shall they use Bourns® products or technology or technical data in any facility which engages in activities relating to such devices. Further, Bourns® products and Bourns' technology and technical data may not under any circumstance be exported or re-exported to countries subject to international sanctions or embargoes. Bourns® products and technology may not, without prior authorization from Bourns and/or the Government of a country where such product/technology is designed and/or manufactured, be resold, transferred, or re-exported (including within the same country) to any party not eligible to receive commodities, software, and technical data originating in such country.

To the maximum extent permitted by applicable law, Bourns disclaims (i) any and all liability for special, punitive, consequential, incidental or indirect damages or lost revenues or lost profits, and (ii) any and all implied warranties (those not based on parameters specified in Bourns' data sheets and/or specifications), including implied warranties of fitness for particular purpose, non-infringement and merchantability.

*For your convenience, copies of this Legal Disclaimer Notice with German, Spanish, Japanese, Traditional Chinese and Simplified Chinese bilingual versions are available at:*

Web Page: <https://www.bourns.com/legal/disclaimers-terms-and-policies>

PDF: <https://www.bourns.com/docs/Legal/disclaimer.pdf>

K2540 05/26R



**CALIFORNIA WARNING:** Can expose you to lead, a carcinogen and reproductive toxicant.

See [www.P65Warnings.ca.gov](http://www.P65Warnings.ca.gov)