



## Features

- Surface Mount SMA package
- Standoff Voltage: 5 to 130 volts
- Power Dissipation: 600 watts
- RoHS compliant\*

## Applications

- Protection of power buses
- Protection of I/O interfaces
- Overvoltage transient protection
- Telecom, computer, industrial and consumer electronics applications

# SMA6J Transient Voltage Suppressor Diode Series

### General Information

Bourns offers Transient Voltage Suppressor Diodes for surge and ESD protection applications, in compact chip package DO-214AC (SMA) size format. The Transient Voltage Suppressor series offers a choice of Working Peak Reverse Voltage from 5 V up to 130 V. Typical fast response times are less than 1.0 picosecond from 0 V to Breakdown Voltage.

Bourns® Chip Diodes are easy to handle with standard pick and place equipment and the flat configuration minimizes roll away.

### Additional Information

Click these links for more information:



### Electrical Characteristics (@ T<sub>A</sub> = 25 °C Unless Otherwise Noted)

Parameter	Symbol	Value	Unit
Minimum Peak Pulse Power Dissipation (T <sub>P</sub> = 1 ms) (Note 1,2)	P <sub>PK</sub>	600	Watts
Peak Forward Surge Current 8.3 ms Single Half Sine Wave Superimposed on Rated Load (JEDEC Method) (Note 3)	I <sub>FSM</sub>	40	Amps
Operating Temperature Range	T <sub>J</sub>	-55 to +150	°C
Storage Temperature Range	T <sub>STG</sub>	-55 to +150	°C

1. Non-repetitive current pulse, per Pulse Waveform graph and derated above T<sub>A</sub> = 25 °C per Pulse Derating Curve.
2. Mounted on 5.0 mm<sup>2</sup> (0.03 mm thick) copper pads to each terminal.
3. 8.3 ms Single Half-Sine Wave duty cycle = 4 pulses maximum per minute (unidirectional units only).



**Asia-Pacific:** Tel: +886-2 2562-4117 • Email: [asiacus@bourns.com](mailto:asiacus@bourns.com)

**EMEA:** Tel: +36 88 885 877 • Email: [eurocus@bourns.com](mailto:eurocus@bourns.com)

**The Americas:** Tel: +1-951 781-5500 • Email: [americus@bourns.com](mailto:americus@bourns.com)

[www.bourns.com](http://www.bourns.com)



**WARNING Cancer and Reproductive Harm - [www.P65Warnings.ca.gov](http://www.P65Warnings.ca.gov)**

\*RoHS Directive 2015/863, Mar 31, 2015 and Annex.

Specifications are subject to change without notice.

Users should verify actual device performance in their specific applications.

The products described herein and this document are subject to specific legal disclaimers as set forth on the last page of this document, and at [www.bourns.com/docs/legal/disclaimer.pdf](http://www.bourns.com/docs/legal/disclaimer.pdf).

# SMA6J Transient Voltage Suppressor Diode Series

## Electrical Characteristics (@ T<sub>A</sub> = 25 °C Unless Otherwise Noted) - Continued

Unidirectional Device		Bidirectional Device		Breakdown Voltage V <sub>BR</sub> (Volts)			Working Peak Reverse Voltage	Maximum Reverse Leakage @ V <sub>RWM</sub>	Maximum Reverse Voltage @ I <sub>RSM</sub>	Maximum Reverse Surge Current
Part No.	Marking	Part No.	Marking	Min.	Max.	@ I <sub>T</sub> (mA)	V <sub>RWM</sub> (V)	I <sub>R</sub> (μA)	V <sub>RSM</sub> (V)	I <sub>RSM</sub> (A)
SMA6J5.0A	6HE	SMA6J5.0CA	6TE	6.40	7.00	10	5.0	800	9.2	65.3
SMA6J6.0A	6HG	SMA6J6.0CA	6TG	6.67	7.37	10	6.0	800	10.3	58.3
SMA6J6.5A	6HK	SMA6J6.5CA	6TK	7.22	7.98	10	6.5	500	11.2	53.6
SMA6J7.0A	6HM	SMA6J7.0CA	6TM	7.78	8.60	10	7.0	200	12.0	50.0
SMA6J7.5A	6HP	SMA6J7.5CA	6TP	8.33	9.21	1.0	7.5	100	12.9	46.6
SMA6J8.0A	6HR	SMA6J8.0CA	6TR	8.89	9.83	1.0	8.0	50	13.6	44.2
SMA6J8.5A	6HT	SMA6J8.5CA	6TT	9.44	10.4	1.0	8.5	20	14.4	41.7
SMA6J9.0A	6HV	SMA6J9.0CA	6TV	10.0	11.1	1.0	9.0	10	15.4	39.0
SMA6J10A	6HX	SMA6J10CA	6TX	11.1	12.3	1.0	10	5	17.0	35.3
SMA6J11A	6HZ	SMA6J11CA	6TZ	12.2	13.5	1.0	11	1.0	18.2	33.0
SMA6J12A	6IE	SMA6J12CA	6UE	13.3	14.7	1.0	12	1.0	19.9	30.2
SMA6J13A	6IG	SMA6J13CA	6UG	14.4	15.9	1.0	13	1.0	21.5	28.0
SMA6J14A	6IK	SMA6J14CA	6UK	15.6	17.2	1.0	14	1.0	23.2	25.9
SMA6J15A	6IM	SMA6J15CA	6UM	16.7	18.5	1.0	15	1.0	24.4	24.6
SMA6J16A	6IP	SMA6J16CA	6UP	17.8	19.7	1.0	16	1.0	26.0	23.1
SMA6J17A	6IR	SMA6J17CA	6UR	18.9	20.9	1.0	17	1.0	27.6	21.8
SMA6J18A	6IT	SMA6J18CA	6UT	20.0	22.1	1.0	18	1.0	29.2	20.6
SMA6J20A	6IV	SMA6J20CA	6UV	22.2	24.5	1.0	20	1.0	32.4	18.6
SMA6J22A	6IX	SMA6J22CA	6UX	24.4	26.9	1.0	22	1.0	35.5	16.9
SMA6J24A	6IZ	SMA6J24CA	6UZ	26.7	29.5	1.0	24	1.0	38.9	15.5
SMA6J26A	6JE	SMA6J26CA	6VE	28.9	31.9	1.0	26	1.0	42.1	14.3
SMA6J28A	6JG	SMA6J28CA	6VG	31.1	34.4	1.0	28	1.0	45.4	13.3
SMA6J30A	6JK	SMA6J30CA	6VK	33.3	36.8	1.0	30	1.0	48.4	12.4
SMA6J33A	6JM	SMA6J33CA	6VM	36.7	40.6	1.0	33	1.0	53.3	11.3
SMA6J36A	6JP	SMA6J36CA	6VP	40	44.2	1.0	36	1.0	58.1	10.4
SMA6J40A	6JR	SMA6J40CA	6VR	44.4	49.1	1.0	40	1.0	64.5	9.3
SMA6J43A	6JT	SMA6J43CA	6VT	47.8	52.8	1.0	43	1.0	69.4	8.7
SMA6J45A	6JV	SMA6J45CA	6VV	50.0	55.3	1.0	45	1.0	72.7	8.3
SMA6J48A	6JX	SMA6J48CA	6VX	53.3	58.9	1.0	48	1.0	77.4	7.8
SMA6J51A	6JZ	SMA6J51CA	6VZ	56.7	62.7	1.0	51	1.0	82.4	7.3
SMA6J54A	6KE	SMA6J54CA	6WE	60.0	66.3	1.0	54	1.0	87.1	6.9
SMA6J58A	6KG	SMA6J58CA	6WG	64.4	71.2	1.0	58	1.0	93.6	6.5
SMA6J60A	6KK	SMA6J60CA	6WK	66.7	73.7	1.0	60	1.0	96.8	6.2
SMA6J64A	6KM	SMA6J64CA	6WM	71.1	78.6	1.0	64	1.0	103.0	5.9
SMA6J70A	6KP	SMA6J70CA	6WP	77.8	86.0	1.0	70	1.0	113.0	5.3
SMA6J75A	6KR	SMA6J75CA	6WR	83.3	92.1	1.0	75	1.0	121.0	5.0
SMA6J78A	6KT	SMA6J78CA	6WT	86.7	95.8	1.0	78	1.0	126.0	4.8
SMA6J85A	6KV	SMA6J85CA	6WV	94.4	104.0	1.0	85	1.0	137.0	4.4
SMA6J90A	6KX	SMA6J90CA	6WX	100.0	111.0	1.0	90	1.0	146.0	4.1
SMA6J100A	6KZ			111.0	123.0	1.0	100	1.0	162.0	3.7
SMA6J110A	6LE			122.0	135.0	1.0	110	1.0	177.0	3.4
SMA6J120A	6LG			133.0	147.0	1.0	120	1.0	193.0	3.1
SMA6J130A	6LK			144.0	159.0	1.0	130	1.0	209.0	2.9

- Notes:
1. Suffix 'A' denotes a 5 % tolerance unidirectional device.
  2. Suffix 'CA' denotes a 5 % tolerance bidirectional device.
  3. For bidirectional devices with a V<sub>RWM</sub> of 10 volts or less, the I<sub>R</sub> limit is double.

Specifications are subject to change without notice.

Users should verify actual device performance in their specific applications.

The products described herein and this document are subject to specific legal disclaimers as set forth on the last page of this document, and at [www.bourns.com/docs/legal/disclaimer.pdf](http://www.bourns.com/docs/legal/disclaimer.pdf).

# SMA6J Transient Voltage Suppressor Diode Series



## Performance Graphs

### Peak Pulse Power Rating

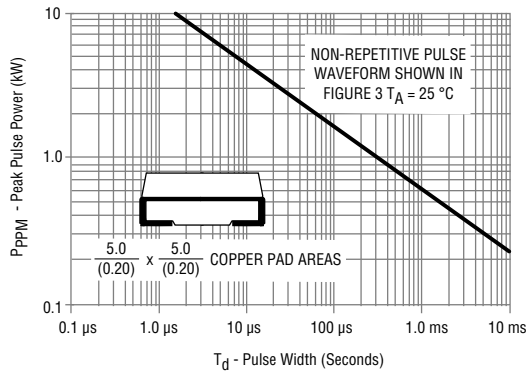

### Pulse Derating Curve

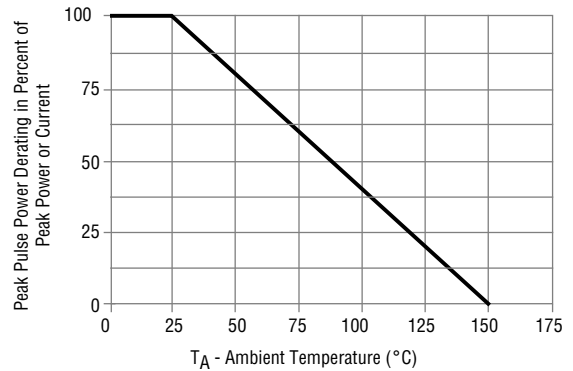

### Pulse Waveform

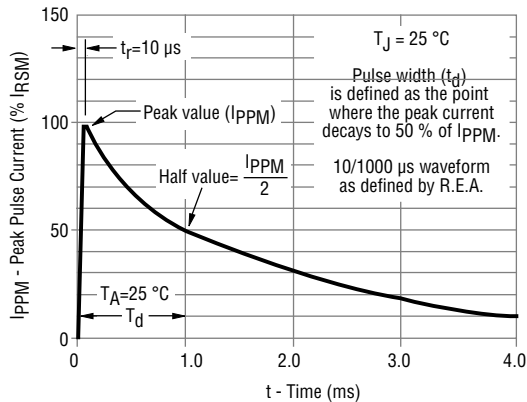

### Typical Junction Capacitance

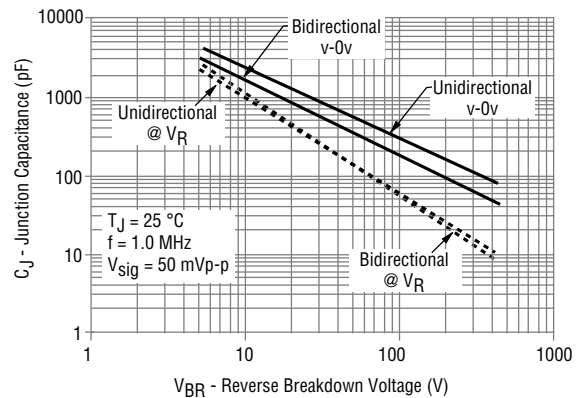

### Steady State Power Derating Curve

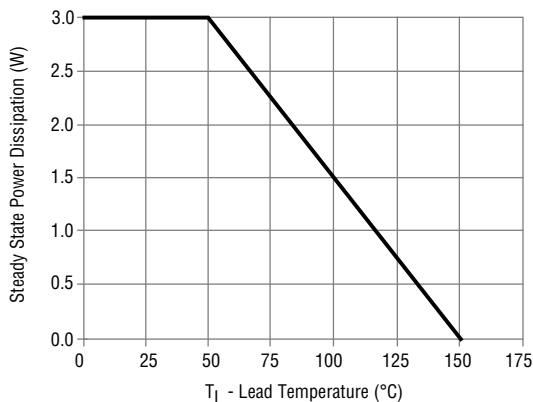

### Maximum Non-repetitive Forward Surge Current

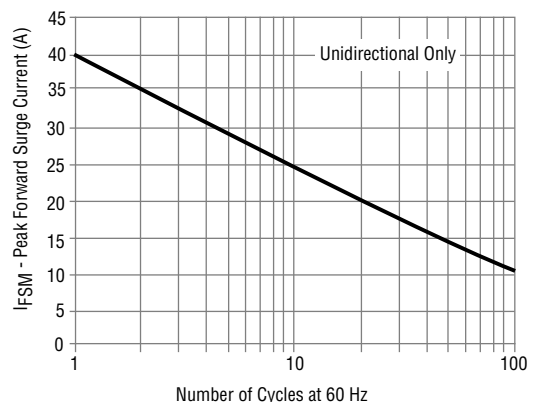

Specifications are subject to change without notice.

Users should verify actual device performance in their specific applications.

The products described herein and this document are subject to specific legal disclaimers as set forth on the last page of this document, and at [www.bourns.com/docs/legal/disclaimer.pdf](http://www.bourns.com/docs/legal/disclaimer.pdf).

# SMA6J Transient Voltage Suppressor Diode Series



## Product Dimensions

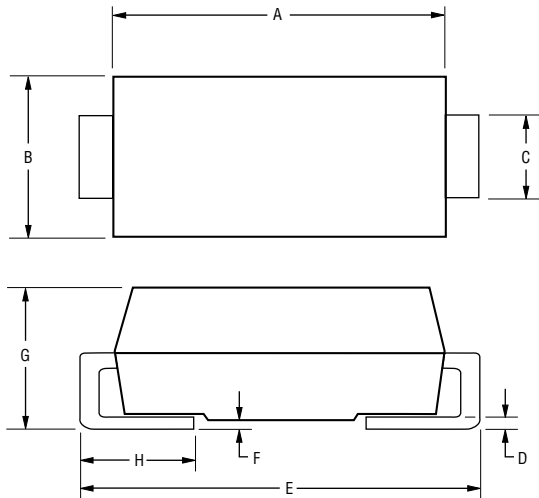

Dimension	SMA (DO-214AC)
A	$\frac{3.99 - 4.50}{(0.157 - 0.177)}$
B	$\frac{2.54 - 2.79}{(0.100 - 0.110)}$
C	$\frac{1.25 - 1.65}{(0.049 - 0.065)}$
D	$\frac{0.15 - 0.31}{(0.006 - 0.012)}$
E	$\frac{4.93 - 5.28}{(0.194 - 0.208)}$
F	$\frac{0.203}{(0.008)}$ MAX.
G	$\frac{1.98 - 2.29}{(0.078 - 0.090)}$
H	$\frac{0.76 - 1.52}{(0.030 - 0.060)}$

DIMENSIONS:  $\frac{\text{MM}}{\text{(INCHES)}}$

## Typical Part Marking

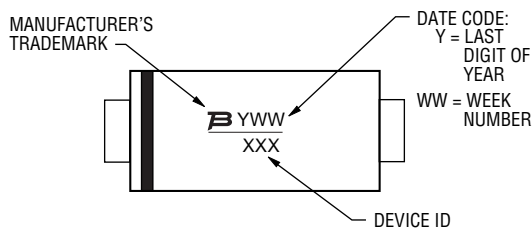

## Recommended Footprint

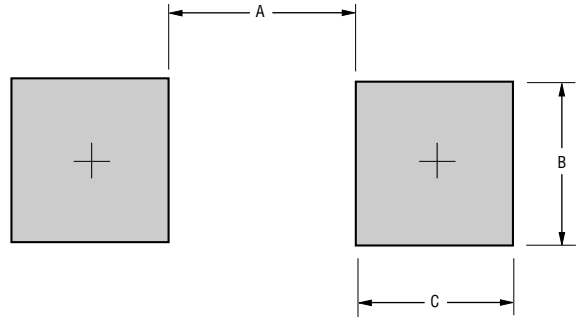

Dimension	SMA (DO-214AC)
A (Max.)	$\frac{2.70}{(0.106)}$
B (Min.)	$\frac{2.10}{(0.083)}$
C (Min.)	$\frac{1.27}{(0.050)}$

DIMENSIONS:  $\frac{\text{MM}}{\text{(INCHES)}}$

## Physical Specifications

Case ..... Molded plastic per UL Class 94V-0  
 Polarity..... Cathode band indicates unidirectional device  
 No cathode band indicates bidirectional device

## How to Order

**SMA6J 5.0 CA**

Package \_\_\_\_\_  
 SMA6J = 600 W, SMA/DO-214AC

Working Peak Reverse Voltage \_\_\_\_\_  
 5.0 - 130 = 5.0 - 130 V<sub>RWM</sub> (Volts)

Suffix \_\_\_\_\_  
 A = 5 % Tolerance Unidirectional Device  
 CA = 5 % Tolerance Bidirectional Device

## Environmental Specifications

Moisture Sensitivity Level ..... 1  
 ESD Classification (HBM) ..... 3B

# SMA6J Transient Voltage Suppressor Diode Series

**BOURNS®**

## Packaging Information

The product will be dispensed in tape and reel format (see diagram below).

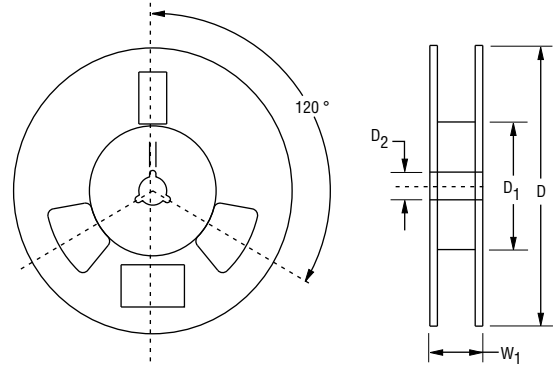
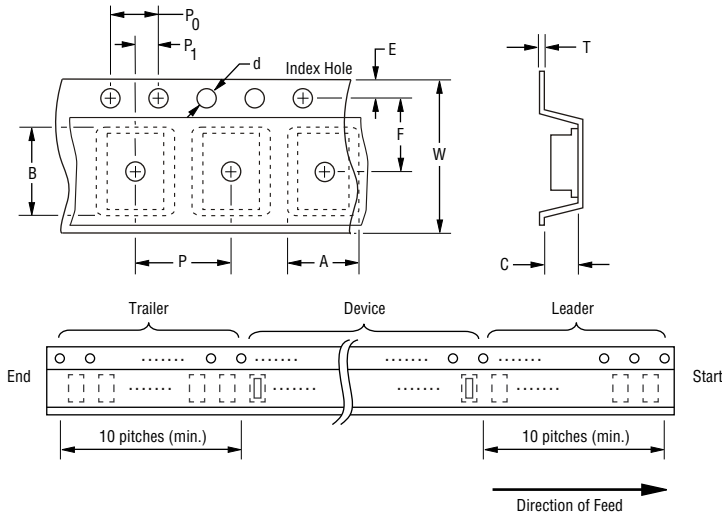

DIMENSIONS:  $\frac{\text{MM}}{\text{(INCHES)}}$

Devices are packed as shown here in compliance with EIA-481-C standard.

Item	Symbol	SMA (DO-214AC)
		13-Inch Reel
Carrier Width	A	$\frac{2.90 \pm 0.20}{(0.114 \pm 0.008)}$
Carrier Length	B	$\frac{5.50 \pm 0.20}{(0.217 \pm 0.008)}$
Carrier Depth	C	$\frac{2.26 \pm 0.20}{(0.089 \pm 0.008)}$
Sprocket Hole	d	$\frac{1.50 \pm 0.10}{(0.061 \pm 0.004)}$
Reel Outside Diameter	D	$\frac{330}{(12.992)}$
Reel Inner Diameter	D <sub>1</sub>	$\frac{50.0}{(1.969)}$ MIN.
Feed Hole Diameter	D <sub>2</sub>	$\frac{13.0 \pm 0.20}{(0.512 \pm 0.008)}$
Sprocket Hole Position	E	$\frac{1.75 \pm 0.10}{(0.069 \pm 0.004)}$
Punch Hole Position	F	$\frac{5.50 \pm 0.05}{(0.217 \pm 0.002)}$
Punch Hole Pitch	P	$\frac{4.00 \pm 0.10}{(0.157 \pm 0.004)}$
Sprocket Hole Pitch	P <sub>0</sub>	$\frac{4.00 \pm 0.10}{(0.157 \pm 0.004)}$
Embossment Center	P <sub>1</sub>	$\frac{2.00 \pm 0.05}{(0.079 \pm 0.002)}$
Overall Tape Thickness	T	$\frac{0.30 \pm 0.10}{(0.012 \pm 0.004)}$
Tape Width	W	$\frac{12.00 \pm 0.30}{(0.472 \pm 0.012)}$
Reel Width	W <sub>1</sub>	$\frac{18.4}{(0.724)}$ MAX.
Quantity per Reel	--	5,000

REV. 7/21

Specifications are subject to change without notice.

Users should verify actual device performance in their specific applications.

The products described herein and this document are subject to specific legal disclaimers as set forth on the last page of this document, and at [www.bourns.com/docs/legal/disclaimer.pdf](http://www.bourns.com/docs/legal/disclaimer.pdf).

This legal disclaimer applies to purchasers and users of Bourns® products manufactured by or on behalf of Bourns, Inc. and its affiliates (collectively, "Bourns").

Unless otherwise expressly indicated in writing, Bourns® products and data sheets relating thereto are subject to change without notice. Users should check for and obtain the latest relevant information and verify that such information is current and complete before placing orders for Bourns® products.

The characteristics and parameters of a Bourns® product set forth in its data sheet are based on laboratory conditions, and statements regarding the suitability of products for certain "typical" applications are based on Bourns' knowledge of typical requirements in generic applications. Bourns assumes that "typical" applications include failsafe/backup features to address critical risks to users and are designed to allow rework of Bourns® product to avoid scrap of a device solely due to malfunctioning Bourns® product. The characteristics and parameters of a Bourns® product in a user application may vary from the data sheet characteristics and parameters due to (i) the combination of the Bourns® product with other components in the user's application, or (ii) the environment of the user application itself. The characteristics and parameters of a Bourns® product also can and do vary in different applications and actual performance may vary over time. Thus, users should always verify the actual performance of the Bourns® product in their specific devices and applications and make their own independent judgments regarding the suitability of Bourns® product and the amount of additional test margin to design into their device or application to compensate for differences between laboratory and real-world conditions.

Unless Bourns has explicitly designated an individual Bourns® product as meeting the requirements of a particular industry standard (e.g., IATF 16949) or a particular qualification (e.g., UL listed or recognized), Bourns is not responsible for any failure of an individual Bourns® product to meet the requirements of such industry standard or particular qualification even if such industry standard or qualification is a "state of art". Users of Bourns® products are responsible for ensuring compliance with safety-related requirements and standards applicable to their devices or applications.

Bourns® products are not recommended, authorized or intended for use in applications where failure or malfunction may result in personal injury, death, or severe property or environmental damage, such as without limitation nuclear, life-critical medical and certain automotive and aviation applications. Except as set forth in the bullet points below or unless expressly and specifically approved in writing on a case-by-case basis by an authorized Bourns' representative, use of any Bourns® products in such unauthorized high-risk applications is at the user's sole risk.

- Bourns considers implantable/invasive devices and devices/procedures designed as life-supporting or life-sustaining by the U.S. Food and Drug Administration or equivalent organizations outside of the United States as "life-critical" medical applications. Bourns expressly identifies those Bourns® standard products that are suitable for use in typical medical applications that are not life-critical in its publication entitled "Bourns Medical Grade Component Guide."
- Bourns expressly identifies those Bourns® standard products that are suitable for use in typical automotive applications associated with any Automate Safety Integrity Level (ASIL) in its publication entitled "Bourns Automotive Grade Component Guide." Bourns' designation of Bourns® product as compliant with the AEC-Q standard does not by itself mean that Bourns has approved such product for use in an automotive application.
- Bourns expressly identifies Bourns® standard products that are suitable for use in the typical aviation applications/systems requiring System Design Assurance Level (RTCA DO-254 DAL) of C, D or E in its publication entitled "Bourns Civilian Aerospace/Aviation Grade Component Guide." Bourns does not test its products for compliance with United States Federal Aviation Administration standards or any other generally equivalent governmental organization standard applicable to products designed or manufactured for use in aviation applications. Use of Bourns® standard components in aviation applications associated with RTCA DO-254 DAL A or B without proper approval noted above shall be at the user's sole risk.
- Bourns will review and authorize on a case-by-case basis the use of Bourns® standard products which are at least AEC-Q compliant in space-related civil applications (rockets, satellites) with a negotiated cross-waiver and indemnity agreement.

The use and level of testing applicable to Bourns® custom products shall be negotiated on a case-by-case basis by Bourns and the user for which such Bourns® custom products are specially designed. Absent a written agreement between Bourns and the user regarding the use and level of such testing, the above provisions applicable to Bourns® standard products shall also apply to such Bourns® custom products.

Use of Bourns® products or Bourns' technology in military/defense applications must be reviewed with Bourns for compliance with applicable export control laws and embargoes. Users shall not sell, transfer, export or re-export (which includes transfers within a country) any Bourns® products or technology or technical data for use in activities which involve the design, development, production, use or stockpiling of nuclear, chemical or biological weapons or missiles, nor shall they use Bourns® products or technology or technical data in any facility which engages in activities relating to such devices. Further, Bourns® products and Bourns' technology and technical data may not under any circumstance be exported or re-exported to countries subject to international sanctions or embargoes. Bourns® products and technology may not, without prior authorization from Bourns and/or the Government of a country where such product/technology is designed and/or manufactured, be resold, transferred, or re-exported (including within the same country) to any party not eligible to receive commodities, software, and technical data originating in such country.

To the maximum extent permitted by applicable law, Bourns disclaims (i) any and all liability for special, punitive, consequential, incidental or indirect damages or lost revenues or lost profits, and (ii) any and all implied warranties (those not based on parameters specified in Bourns' data sheets and/or specifications), including implied warranties of fitness for particular purpose, non-infringement and merchantability.

For your convenience, copies of this Legal Disclaimer Notice with German, Spanish, Japanese, Traditional Chinese and Simplified Chinese bilingual versions are available at:

Web Page: <https://www.bourns.com/legal/disclaimers-terms-and-policies>

PDF: <https://www.bourns.com/docs/Legal/disclaimer.pdf>