



BIDIRECTIONAL THYRISTOR OVERVOLTAGE PROTECTORS

TISP4360H3BJ Overvoltage Protector Series

Matched to FCC Part 68 POTS + ADSL Voltages

- Working Voltage, V_{DRM} 290 V
- Protection Voltage, $V_{(BO)}$ 360 V

High FCC, Bellcore & ITU-T Surge Ratings

Waveshape	Standard	I_{TSP} A
2/10 μ s	GR-1089-CORE	500
8/20 μ s	IEC 61000-4-5	300
10/160 μ s	FCC Part 68	250
10/700 μ s	ITU-T K.20/21 FCC Part 68	200
10/560 μ s	FCC Part 68	160
10/1000 μ s	GR-1089-CORE	100

High UL 1950, Bellcore & ITU-T AC Capability

Standard	Applied AC A r.m.s.	'4360 $I_{T(OV)M}$ Limits
UL 1950 (ANNEX NAC)	40	0.04
	7	4.2
	2.2	SURVIVES
GR-1089-CORE	60	0.015
	30	0.08
	15	0.48
	2.2	SURVIVES
ITU-T K.20/21	23	0.15
	1	SURVIVES

SMBJ Package (Top View)

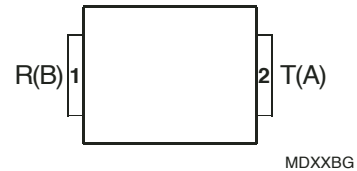

Device Symbol

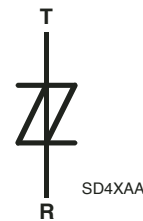

Terminals T and R correspond to the alternative line designators of A and B

Large creepage distance 2.54 mm (0.1 in.)

Low Capacitance 24 pF @ 50 V
70 pF @ 0

..... **UL Recognized Component**

Description

The TISP4360H3BJ is designed to limit overvoltages on equipment used for telephone lines carrying POTS (Plain Old Telephone System) and ADSL (Asymmetrical Digital Subscriber Line) signals. TISP4360H3BJ a.c. overload limits are specified for designers to select the correct overcurrent protectors to meet safety requirements, e.g. UL 1950.

The protector consists of a symmetrical voltage-triggered bidirectional thyristor. Overvoltages are initially clipped by breakdown clamping. If sufficient current is available from the overvoltage, the breakdown voltage will rise to the breakover level, which causes the device to switch into a low-voltage on-state condition. This switching action removes the high voltage stress from the following circuitry and causes the current resulting from the overvoltage to be safely diverted through the protector. The high holding (switch off) current helps prevent d.c. latchup as the diverted current subsides.

The TISP4360H3BJ is guaranteed to voltage limit and withstand the listed international lightning surges in both polarities. This high (H) current protection device is in a plastic SMBJ package (JEDEC DO-214AA with J-bend leads) and supplied in embossed carrier reel pack. For alternative voltage and holding current values, consult the factory.

How To Order

Device	Package	Carrier	Order As
TISP4360H3BJ	BJ (J-Bend DO-214AA/SMB)	Embossed Tape Reeled	TISP4360H3BJR-S



WARNING Cancer and Reproductive Harm
www.P65Warnings.ca.gov

JUNE 1999 - REVISED JANUARY 2007

*RoHS Directive 2002/95/EC Jan. 27, 2003 including Annex.

Specifications are subject to change without notice. Users should verify actual device performance in their specific applications. The products described herein and this document are subject to specific legal disclaimers as set forth on the last page of this document, and at www.bourns.com/docs/legal/disclaimer.pdf.

TISP4360H3BJ Overvoltage Protector Series

BOURNS®

Absolute Maximum Ratings, $T_A = 25\text{ }^\circ\text{C}$ (Unless Otherwise Noted)

Rating	Symbol	Value	Unit
Repetitive peak off-state voltage, (see Note 1)	V_{DRM}	± 290	V
Non-repetitive peak on-state pulse current (see Notes 2, 3 and 4)	I_{TSP}	2/10 μs (GR-1089-CORE, 2/10 μs voltage wave shape)	500
8/20 μs (IEC 61000-4-5, 1.2/50 μs voltage, 8/20 current combination wave generator)		300	
10/160 μs (FCC Part 68, 10/160 μs voltage wave shape)		250	
5/200 μs (VDE 0433, 10/700 μs voltage wave shape)		220	
0.2/310 μs (I3124, 0.5/700 μs voltage wave shape)		200	
5/310 μs (ITU-T K.20/21, 10/700 μs voltage wave shape)		200	
5/310 μs (FTZ R12, 10/700 μs voltage wave shape)		200	
10/560 μs (FCC Part 68, 10/560 μs voltage wave shape)		160	
10/1000 μs (GR-1089-CORE, 10/1000 μs voltage wave shape)		100	
Non-repetitive peak on-state current (see Notes 2, 3 and 5)	I_{TSM}	20 ms (50 Hz) full sine wave	55
16.7 ms (60 Hz) full sine wave		60	
1000 s 50 Hz/60 Hz a.c.		2.2	
Maximum overload on-state current without open circuit, 50 Hz/60 Hz a.c.	$I_{T(OV)M}$	0.015 s	60
0.04 s		40	
0.08 s		30	
0.15 s		23	
0.48 s		15	
4.2 s		7	
Initial rate of rise of on-state current, Exponential current ramp, Maximum ramp value < 200 A	di_T/dt	400	A/ μs
Junction temperature	T_J	-40 to +150	$^\circ\text{C}$
Storage temperature range	T_{stg}	-65 to +150	$^\circ\text{C}$

- NOTES: 1. See Applications Information and Figure 9 for voltage values at lower temperatures.
 2. Initially, the TISP4360H3BJ must be in thermal equilibrium with $T_J = 25\text{ }^\circ\text{C}$.
 3. The surge may be repeated after the TISP4360H3BJ returns to its initial conditions.
 4. See Applications Information and Figure 10 for current ratings at other temperatures.
 5. EIA/JESD51-2 environment and EIA/JESD51-3 PCB with standard footprint dimensions connected with 5 A rated printed wiring track widths. See Figure 7 for the current ratings at other durations. Derate current values at $-0.61\text{ }^\circ\text{C}$ for ambient temperatures above $25\text{ }^\circ\text{C}$.

Electrical Characteristics, $T_A = 25\text{ }^\circ\text{C}$ (Unless Otherwise Noted)

Parameter	Test Conditions	Min.	Typ.	Max.	Unit
I_{DRM} Repetitive peak off-state current	$V_D = V_{DRM}$ $T_A = 25\text{ }^\circ\text{C}$ $T_A = 85\text{ }^\circ\text{C}$			± 5 ± 10	μA
$V_{(BO)}$ Breakover voltage	$dv/dt = \pm 750\text{ V/ms}$, $R_{SOURCE} = 300\ \Omega$			± 360	V
$V_{(BO)}$ Impulse breakover voltage	$dv/dt \leq \pm 1000\text{ V}/\mu\text{s}$, Linear voltage ramp, Maximum ramp value = $\pm 500\text{ V}$ $di/dt = \pm 20\text{ A}/\mu\text{s}$, Linear current ramp, Maximum ramp value = $\pm 10\text{ A}$			± 372	V
$I_{(BO)}$ Breakover current	$dv/dt = \pm 750\text{ V/ms}$, $R_{SOURCE} = 300\ \Omega$	± 0.15		± 0.8	A
V_T On-state voltage	$I_T = \pm 5\text{ A}$, $t_W = 100\ \mu\text{s}$			± 3	V
I_H Holding current	$I_T = \pm 5\text{ A}$, $di/dt = -/+ 30\text{ mA/ms}$	± 0.225		± 0.8	A
dv/dt Critical rate of rise of off-state voltage	Linear voltage ramp, Maximum ramp value < $0.85V_{DRM}$	± 5			kV/ μs
I_D Off-state current	$V_D = \pm 50\text{ V}$ $T_A = 85\text{ }^\circ\text{C}$			± 10	μA

JUNE 1999 - REVISED JANUARY 2007

Specifications are subject to change without notice.

Users should verify actual device performance in their specific applications.

The products described herein and this document are subject to specific legal disclaimers as set forth on the last page of this document, and at www.bourns.com/docs/legal/disclaimer.pdf.

TISP4360H3BJ Overvoltage Protector Series

BOURNS®

Electrical Characteristics, $T_A = 25\text{ }^\circ\text{C}$ (Unless Otherwise Noted) (continued)

Parameter	Test Conditions	Min.	Typ.	Max.	Unit
C_{off} Off-state capacitance	$f = 100\text{ kHz}$, $V_d = 1\text{ V rms}$, $V_D = 0$,		70	84	pF
	$f = 100\text{ kHz}$, $V_d = 1\text{ V rms}$, $V_D = -1\text{ V}$		60	67	
	$f = 100\text{ kHz}$, $V_d = 1\text{ V rms}$, $V_D = -2\text{ V}$		55	62	
	$f = 100\text{ kHz}$, $V_d = 1\text{ V rms}$, $V_D = -50\text{ V}$		24	28	
	$f = 100\text{ kHz}$, $V_d = 1\text{ V rms}$, $V_D = -100\text{ V}$		22	26	

Thermal Characteristics

Parameter	Test Conditions	Min.	Typ.	Max.	Unit
$R_{\theta JA}$ Junction to free air thermal resistance	EIA/JESD51-3 PCB, $I_T = I_{TSM(1000)}$, $T_A = 25\text{ }^\circ\text{C}$, (see Note 6)			113	$^\circ\text{C/W}$
	265 mm x 210 mm populated line card, 4-layer PCB, $I_T = I_{TSM(1000)}$, $T_A = 25\text{ }^\circ\text{C}$		50		

NOTE 6: EIA/JESD51-2 environment and PCB has standard footprint dimensions connected with 5 A rated printed wiring track widths.

Parameter Measurement Information

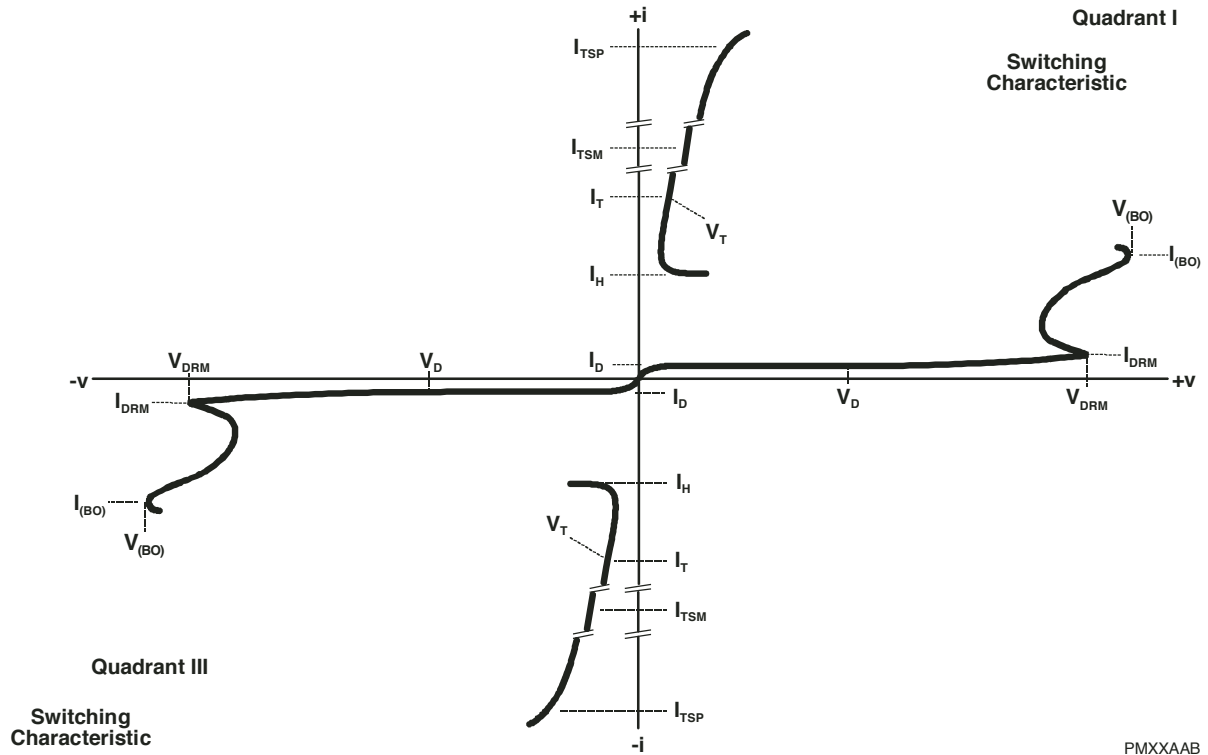

**Figure 1. Voltage-current Characteristic for T and R Terminals
All Measurements are Referenced to the R Terminal**

PMXXAAB

Typical Characteristics

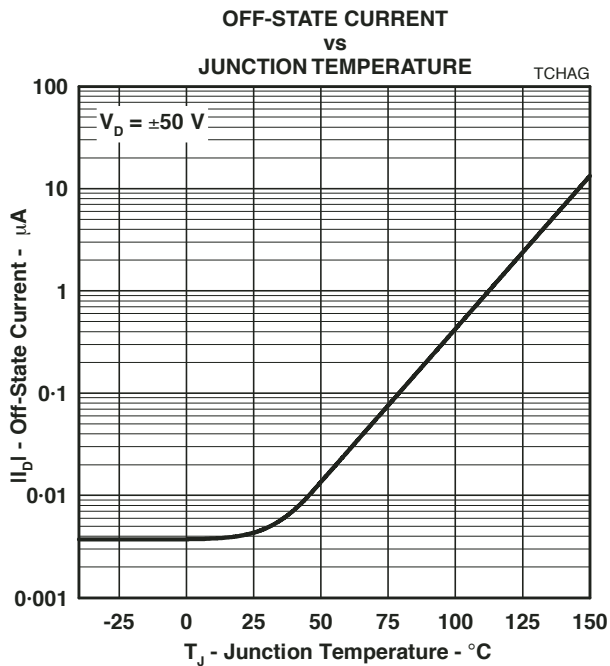

Figure 2.

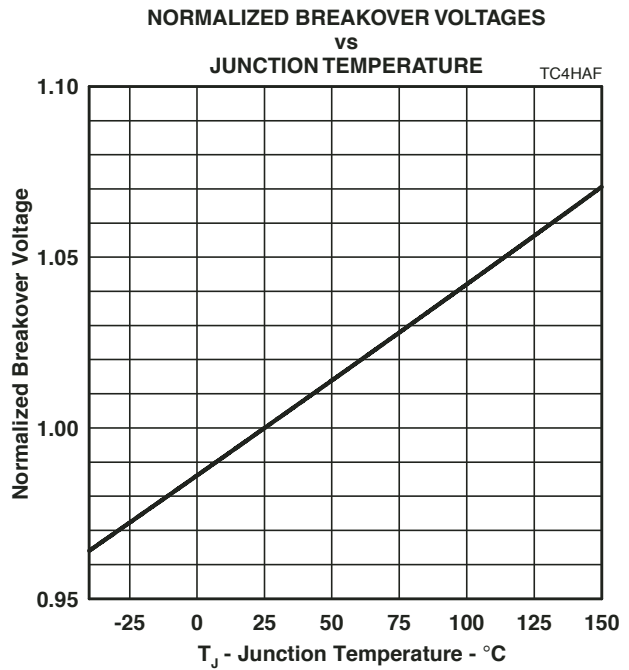

Figure 3.

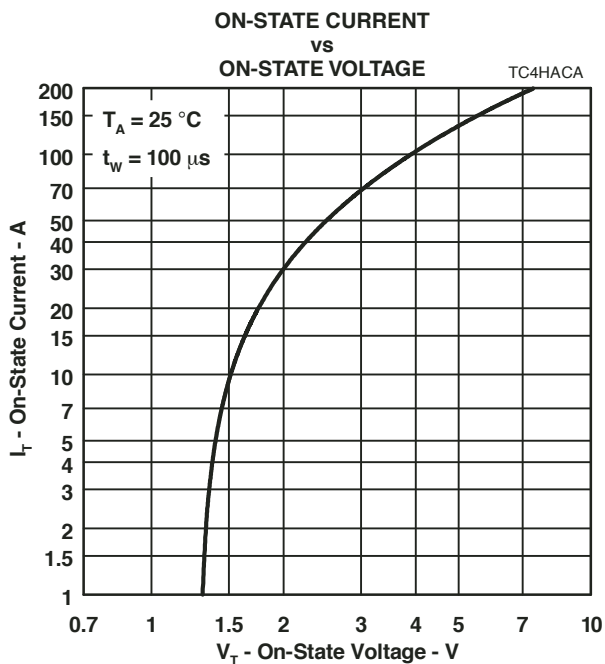

Figure 4.

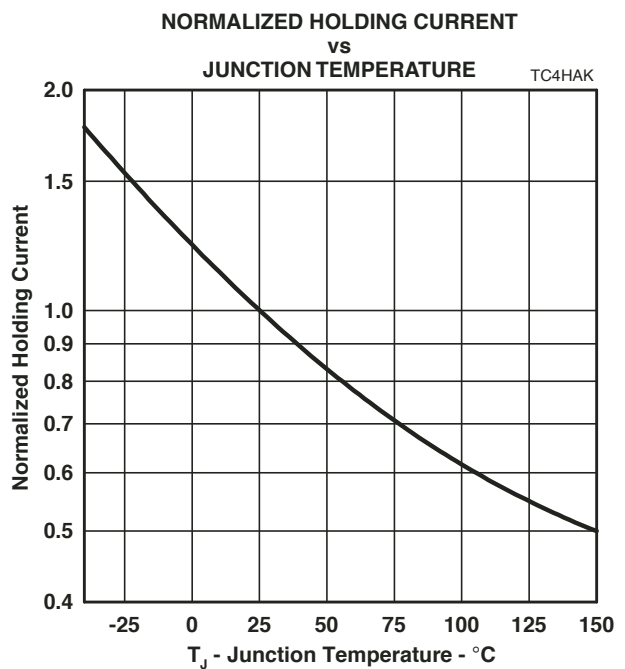

Figure 5.

Typical Characteristics

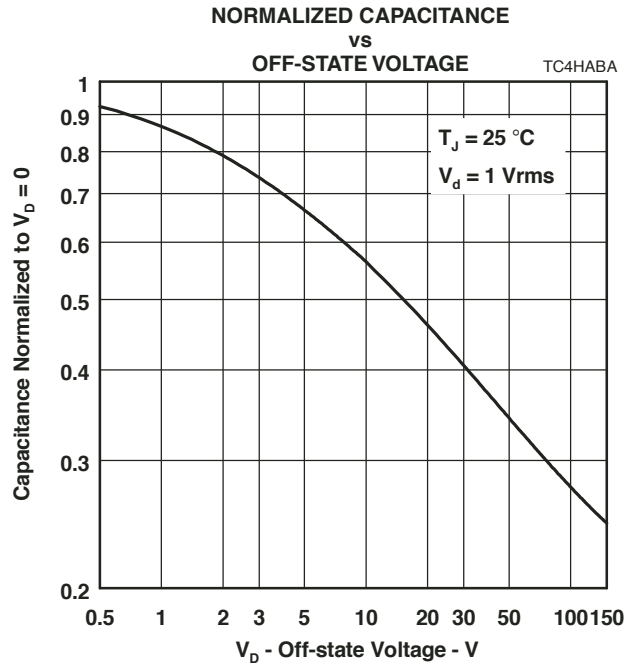
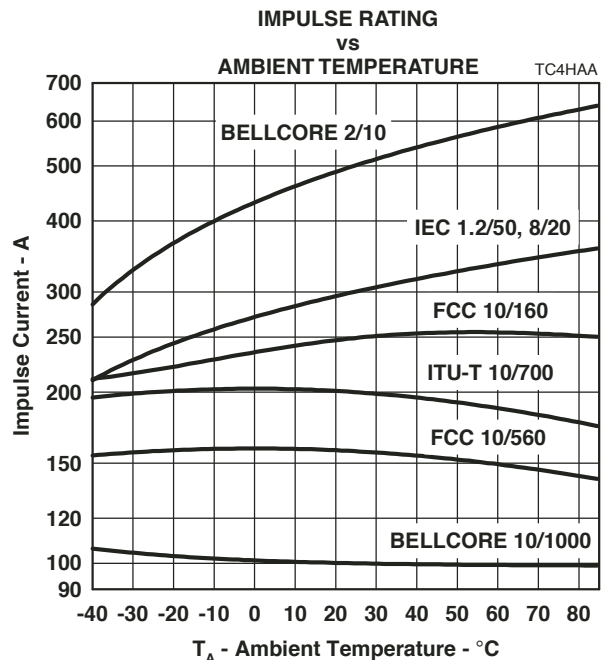
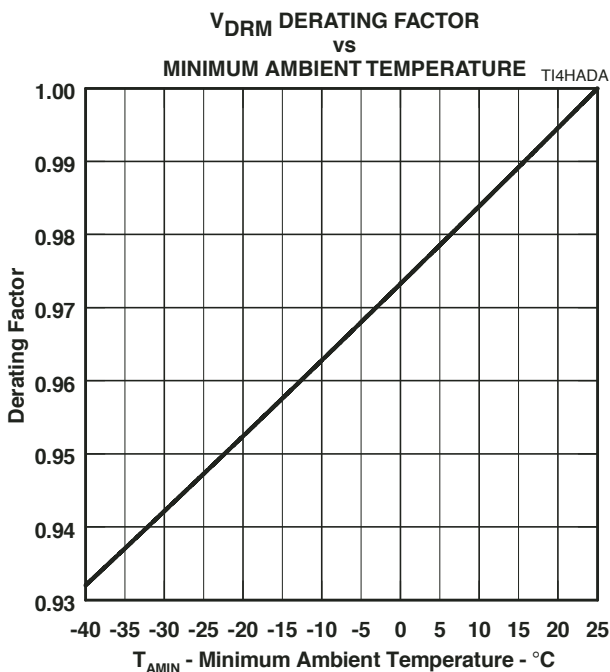
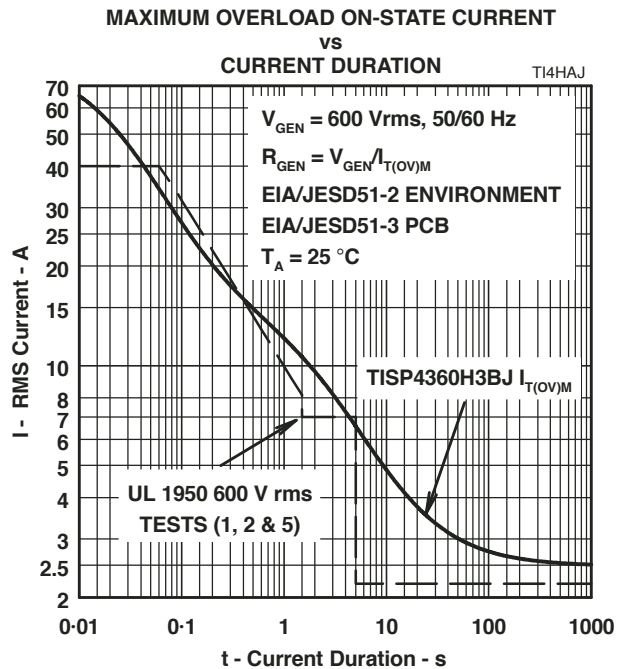
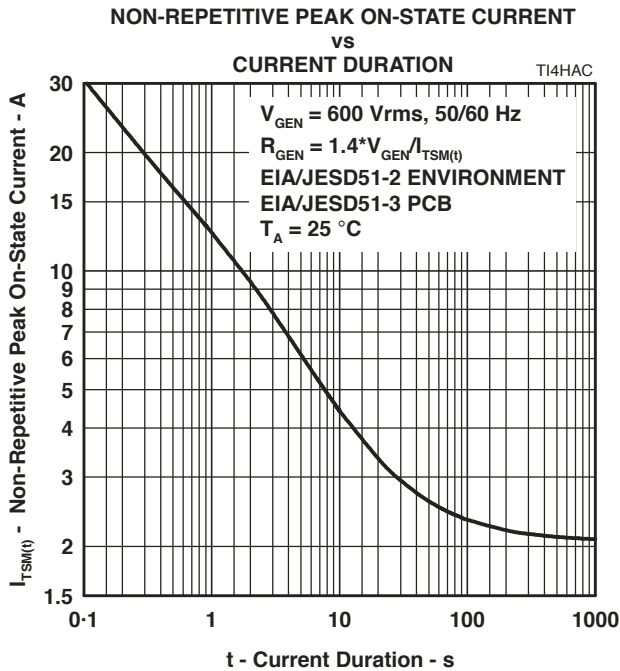

Figure 6.

Rating and Thermal Information



APPLICATIONS INFORMATION

Deployment

These devices are two terminal overvoltage protectors. They may be used either singly to limit the voltage between two conductors (Figure 11) or in multiples to limit the voltage at several points in a circuit (Figure 12).

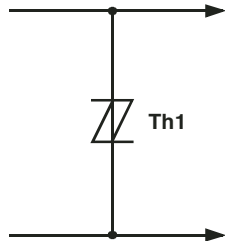

Figure 11. Two Point Protection

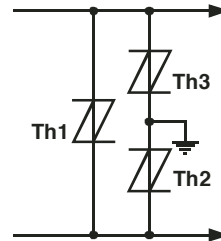

Figure 12. Multi-point Protection

In Figure 11, protector Th1 limits the maximum voltage between the two conductors to $\pm V_{(BO)}$. This configuration is normally used to protect circuits without a ground reference, such as modems. In Figure 12, protectors Th2 and Th3 limit the maximum voltage between each conductor and ground to the $\pm V_{(BO)}$ of the individual protector. Protector Th1 limits the maximum voltage between the two conductors to its $\pm V_{(BO)}$ value. If the equipment being protected has all its vulnerable components connected between the conductors and ground, then protector Th1 is not required.

Impulse Testing

To verify the withstand capability and safety of the equipment, standards require that the equipment is tested with various impulse wave forms. The table below shows some common values.

Standard	Peak Voltage Setting V	Voltage Waveform μs	Peak Current Value A	Current Waveform μs	TISP4360H3BJ 25 °C Rating A	Series Resistance Ω
GR-1089-CORE	2500	2/10	500	2/10	500	0
	1000	10/1000	100	10/1000	100	
FCC Part 68 (March 1998)	1500	10/160	200	10/160	250	0
	800	10/560	100	10/560	160	0
	1500	9/720 †	37.5	5/320 †	200	0
	1000	9/720 †	25	5/320 †	200	0
I3124	1500	0.5/700	37.5	0.2/310	200	0
ITU-T K.20/K.21	1500	10/700	37.5	5/310	200	0
	4000		100			

† FCC Part 68 terminology for the waveforms produced by the ITU-T recommendation K.21 10/700 impulse generator

Series resistance can be added to cover situations where either the TISP4360H3BJ current rating will be exceeded or excessive wiring currents result or both.

When a primary protector is used, the TISP4360H3BJ may operate before the primary protector. With the TISP4360H3BJ in a low voltage state, the primary protector is prevented from working. High currents, which should have been carried by the primary protector, now flow through the wiring to the equipment and through the TISP4360H3BJ. Interference and network equipment damage can occur, particularly if the currents are diverted to the local ground. Protector coordination prevents this problem. A series resistor can be used to develop a voltage drop large enough to activate the primary protector. If the primary protector was a gas discharge tube (GDT) with a maximum d.c. sparkover of 400 V and the typical lightning impulse decay time was several hundred microseconds (TISP4360H3BJ rating 200 A), a 2 Ω series resistor (400 V/200 A) would be sufficient to achieve coordination. At peak currents of 200 A and above, the resistor would develop at least 400 V and GDT would switch and divert the current.

APPLICATIONS INFORMATION

Impulse Testing (continued)

If the impulse generator current exceeds the protector's current rating, then a series resistance can be used to reduce the current to the protector's rated value to prevent possible failure. The required value of series resistance for a given waveform is given by the following calculations. First, the minimum total circuit impedance is found by dividing the impulse generator's peak voltage by the protector's rated current. The impulse generator's fictive impedance (generator's peak voltage divided by peak short circuit current) is then subtracted from the minimum total circuit impedance to give the required value of series resistance. In some cases, the equipment will require verification over a temperature range. By using the rated waveform values from Figure 10, the appropriate series resistor value can be calculated for ambient temperatures in the range of -40 °C to 85 °C.

AC Testing

The protector can withstand currents applied for times not exceeding those shown in Figure 7. Currents that exceed these times must be terminated or reduced to avoid protector failure. Fuses, PTC (Positive Temperature Coefficient) resistors and fusible resistors are overcurrent protection devices which can be used to reduce the current flow. Protective fuses may range from a few hundred milliamperes to one ampere. In some cases, it may be necessary to add some extra series resistance to prevent the fuse from opening during impulse testing. The current versus time characteristic of the overcurrent protector must be below the line shown in Figure 7. In some cases, there may be a further time limit imposed by the test standard (e.g. UL 1459/1950 wiring simulator failure).

Safety tests require that the equipment fails without any hazard to the user. For the equipment protector, this condition usually means that the fault mode is short circuit, ensuring that the following circuitry is not exposed to high voltages. The ratings table and Figure 8 detail the earliest times when a shorted condition could occur. Figure 8 shows how the protector current levels compare to UL 1950 levels. Only the UL 1950 600 V tests (1, 2 and 3) are shown, as these have sufficient voltage to operate the protector. Tests 4 (<285 V peak, 2.2 A) and 5 (120 V rms, 25 A) are too low in voltage to operate the protector.

Figure 8 shows that the TISP4360H3BJ curve is very close or better than the UL 1950 test levels. Design compliance is simply a matter of selecting an overcurrent protector which operates before the UL 1950 times up to 1.5 s. Fuses such as the Littelfuse® 436 series and 2AG (Surge Withstand type) series have a 600 V capability for UL 1950. Fuses rated in the range of 0.5 A to 1.5 A will usually meet the safety test requirements. However, the lower rated current value fuses may open on the type A surges of FCC Part 68. Opening on a type A surge is not a test failure, but opening on a type B surge (37.5 A 5/320) is; so the selected fuse must be able to withstand the type B surge.

Capacitance

The protector characteristic off-state capacitance values are given for d.c. bias voltage, V_D , values of 0, -1 V, -2 V, -50 V and -100 V. Values for other voltages may be calculated by multiplying the $V_D = 0$ capacitance value by the factor given in Figure 6. Up to 10 MHz, the capacitance is essentially independent of frequency. Above 10 MHz, the effective capacitance is strongly dependent on connection inductance.

Normal System Voltage Levels

The protector should not clip or limit the voltages that occur in normal system operation. If the maximum system voltages are not known, then designers often used the voltages for the FCC Part 68 "B" ringer. The "B" ringer has a d.c. voltage of 56.5 and a maximum a.c. ring voltage of 150 V rms. The resultant waveform is shown in Figure 13. The maximum voltage is -269 V, but, because of possible wiring reversals, the protector should have a working voltage of ± 269 V minimum. The standard TISP4350H3BJ protector meets this requirement with a working voltage, V_{DRM} , of ± 275 V and a protection voltage, $V_{(BO)}$, of ± 350 V. Figure 14 shows the TISP4350H3BJ voltages relative to the POTS -269 V peak ringing voltage.

The ADSL signal can be as high as ± 15 V and this adds to the POTS signal, making a peak value of -284 V. This increased signal value of -284 V would be clipped by the TISP4350H3BJ, which only allows for a -275 V signal. The TISP4360H3BJ has been specified to overcome this problem by having a higher working voltage of ± 290 V. Figure 15 shows the TISP4360H3BJ voltages relative to the -284 V peak ADSL plus POTS ringing voltage. The ± 15 V ADSL signal is shown as a grey band in Figure 15.

The recommended PCB pad layout for the TISP4360H3BJ SMB package (see mechanical section) gives a creepage distance of 2.54 mm between the device terminals. This distance value allows compliance to the minimum clearance values required by UL 1950 for operational, basic and supplementary insulation and creepage values for pollution degree 1.

APPLICATIONS INFORMATION

Normal System Voltage Levels

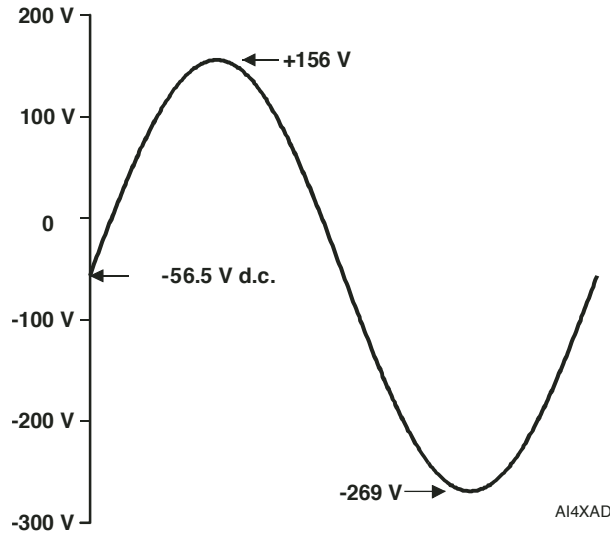

Figure 13.

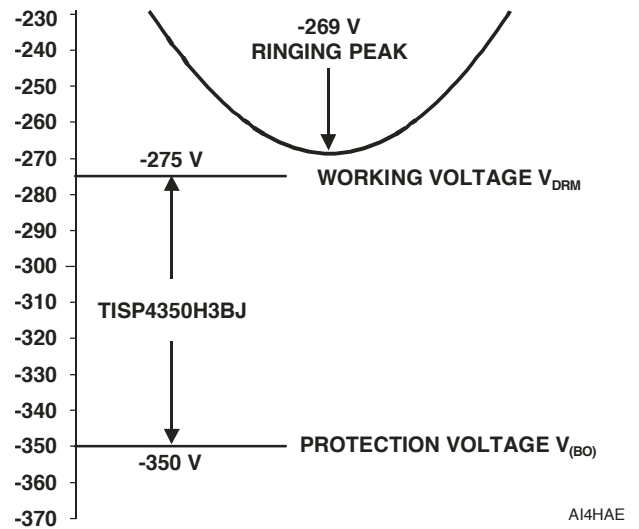

Figure 14.

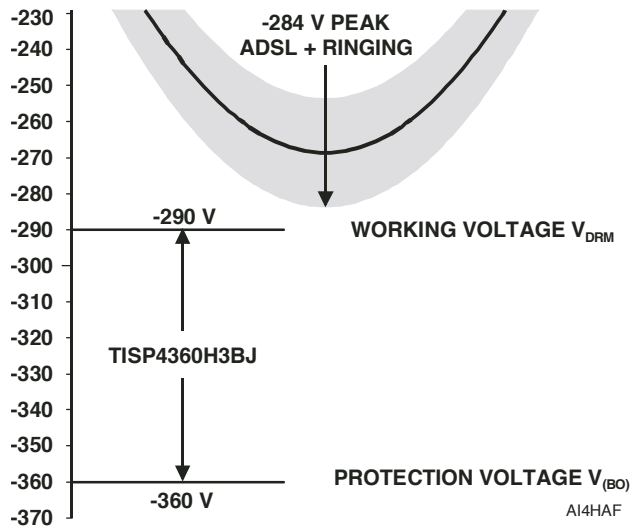

Figure 15.

JESD51 Thermal Measurement Method

To standardize thermal measurements, the JEDEC has created the JESD51 standard. Part 2 of the standard (JESD51-2, 1995) describes the test environment. This is a 0.0283 m³ (1 ft³) cube which contains the test PCB (Printed Circuit Board) horizontally mounted at the center. Part 3 of the standard (JESD51-3, 1996) defines two test PCBs for surface mount components; one for packages smaller than 27 mm (1.06 ") on a side and the other for packages up to 48 mm (1.89 "). The SMBJ measurements used the smaller 76.2 mm x 114.3 mm (3.0 " x 4.5 ") PCB. The JESD51-3 PCBs are designed to have low effective thermal conductivity (high thermal resistance) and represent a worse case condition. The PCBs used in the majority of applications will achieve lower values of thermal resistance and so can dissipate higher power levels than indicated by the JESD51 values.

JUNE 1999 - REVISED JANUARY 2007

Specifications are subject to change without notice.

Users should verify actual device performance in their specific applications.

The products described herein and this document are subject to specific legal disclaimers as set forth on the last page of this document, and at www.bourns.com/docs/legal/disclaimer.pdf.

Typical Circuits

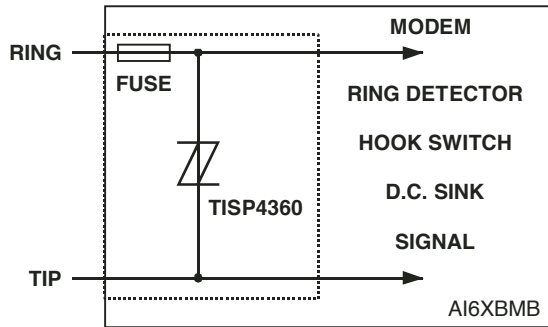

Figure 16. Modem Inter-wire Protection

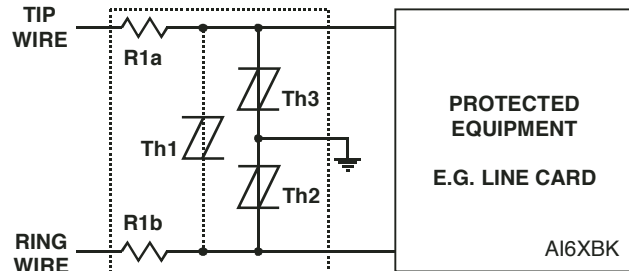

Figure 17. Protection Module

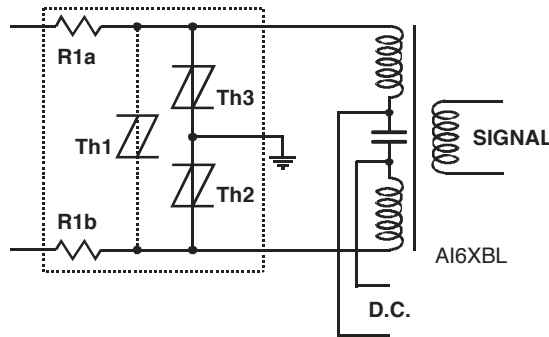

Figure 18. ISDN Protection

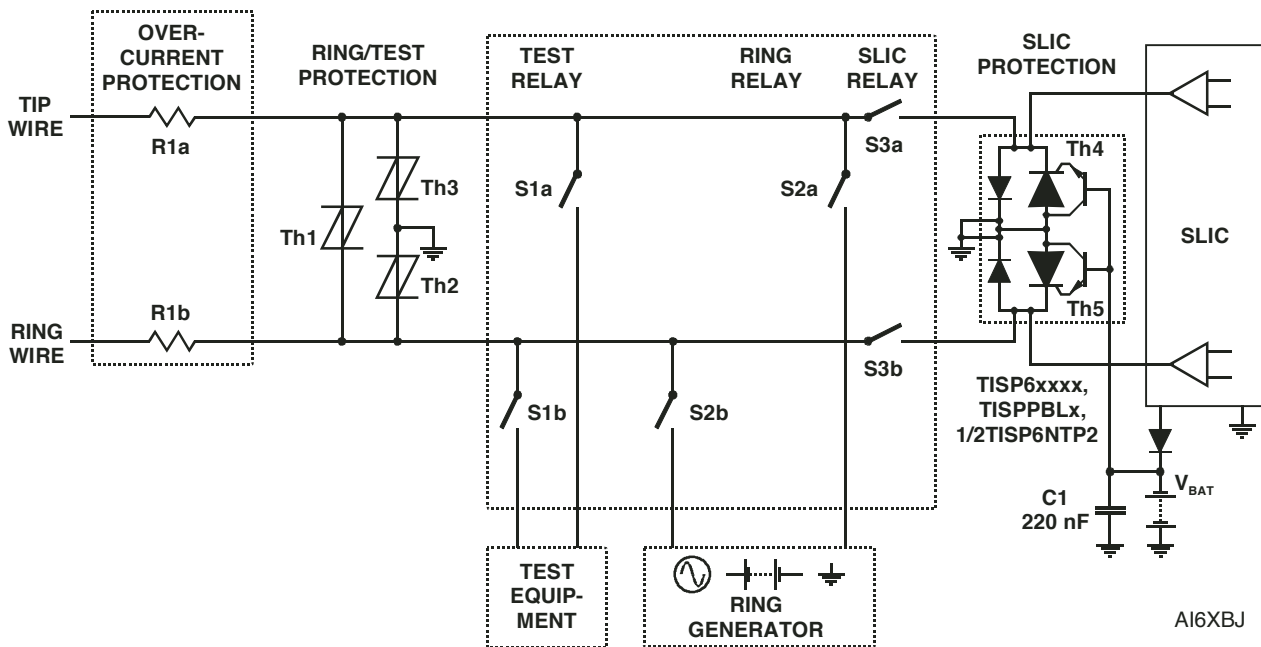

Figure 19. Line Card Ring/Test Protection

TISP4360H3BJ Overvoltage Protector Series

BOURNS®

MECHANICAL DATA

Recommended Printed Wiring Footprint

SMB Pad Size

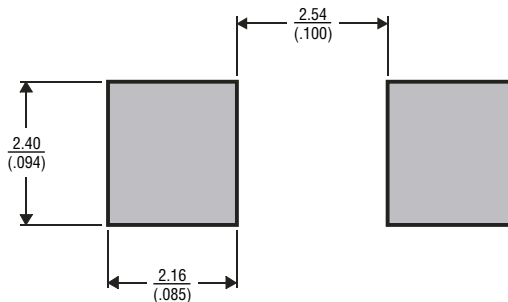

DIMENSIONS ARE: $\frac{\text{METRIC}}{\text{(INCHES)}}$

MDXXBI

Device Symbolization Code

Devices will be coded as below. As the device parameters are symmetrical, terminal 1 is not identified.

Device	Symbolization Code
TISP4360H3BJ	4360H3

Carrier Information

Devices are shipped in one of the carriers below. Unless a specific method of shipment is specified by the customer, devices will be shipped in the most practical carrier. For production quantities, the carrier will be embossed tape reel pack. Evaluation quantities may be shipped in bulk pack or embossed tape.

Carrier	Order As
Embossed Tape Reel Pack	TISP4360H3BJR-S
Bulk Pack	TISP4360H3BJ-S

"TISP" is a trademark of Bourns, Ltd., a Bourns Company, and is Registered in U.S. Patent and Trademark Office.
"Bourns" is a registered trademark of Bourns, Inc. in the U.S. and other countries.

JUNE 1999 - REVISED JANUARY 2007

Specifications are subject to change without notice.

Users should verify actual device performance in their specific applications.

The products described herein and this document are subject to specific legal disclaimers as set forth on the last page of this document, and at www.bourns.com/docs/legal/disclaimer.pdf.

This legal disclaimer applies to purchasers and users of Bourns® products manufactured by or on behalf of Bourns, Inc. and its affiliates (collectively, “Bourns”).

Unless otherwise expressly indicated in writing, Bourns® products and data sheets relating thereto are subject to change without notice. Users should check for and obtain the latest relevant information and verify that such information is current and complete before placing orders for Bourns® products.

The characteristics and parameters of a Bourns® product set forth in its data sheet are based on laboratory conditions, and statements regarding the suitability of products for certain types of applications are based on Bourns’ knowledge of typical requirements in generic applications. The characteristics and parameters of a Bourns® product in a user application may vary from the data sheet characteristics and parameters due to (i) the combination of the Bourns® product with other components in the user’s application, or (ii) the environment of the user application itself. The characteristics and parameters of a Bourns® product also can and do vary in different applications and actual performance may vary over time. Users should always verify the actual performance of the Bourns® product in their specific devices and applications, and make their own independent judgments regarding the amount of additional test margin to design into their device or application to compensate for differences between laboratory and real world conditions.

Unless Bourns has explicitly designated an individual Bourns® product as meeting the requirements of a particular industry standard (e.g., ISO/TS 16949) or a particular qualification (e.g., UL listed or recognized), Bourns is not responsible for any failure of an individual Bourns® product to meet the requirements of such industry standard or particular qualification. Users of Bourns® products are responsible for ensuring compliance with safety-related requirements and standards applicable to their devices or applications.

Bourns® products are not recommended, authorized or intended for use in nuclear, lifesaving, life-critical or life-sustaining applications, nor in any other applications where failure or malfunction may result in personal injury, death, or severe property or environmental damage. Unless expressly and specifically approved in writing by two authorized Bourns representatives on a case-by-case basis, use of any Bourns® products in such unauthorized applications might not be safe and thus is at the user’s sole risk. Life-critical applications include devices identified by the U.S. Food and Drug Administration as Class III devices and generally equivalent classifications outside of the United States.

Bourns expressly identifies those Bourns® standard products that are suitable for use in automotive applications on such products’ data sheets in the section entitled “Applications.” Unless expressly and specifically approved in writing by two authorized Bourns representatives on a case-by-case basis, use of any other Bourns® standard products in an automotive application might not be safe and thus is not recommended, authorized or intended and is at the user’s sole risk. If Bourns expressly identifies a sub-category of automotive application in the data sheet for its standard products (such as infotainment or lighting), such identification means that Bourns has reviewed its standard product and has determined that if such Bourns® standard product is considered for potential use in automotive applications, it should only be used in such sub-category of automotive applications. Any reference to Bourns® standard product in the data sheet as compliant with the AEC-Q standard or “automotive grade” does not by itself mean that Bourns has approved such product for use in an automotive application.

Bourns® standard products are not tested to comply with United States Federal Aviation Administration standards generally or any other generally equivalent governmental organization standard applicable to products designed or manufactured for use in aircraft or space applications. Bourns expressly identifies Bourns® standard products that are suitable for use in aircraft or space applications on such products’ data sheets in the section entitled “Applications.” Unless expressly and specifically approved in writing by two authorized Bourns representatives on a case-by-case basis, use of any other Bourns® standard product in an aircraft or space application might not be safe and thus is not recommended, authorized or intended and is at the user’s sole risk.

The use and level of testing applicable to Bourns® custom products shall be negotiated on a case-by-case basis by Bourns and the user for which such Bourns® custom products are specially designed. Absent a written agreement between Bourns and the user regarding the use and level of such testing, the above provisions applicable to Bourns® standard products shall also apply to such Bourns® custom products.

Users shall not sell, transfer, export or re-export any Bourns® products or technology for use in activities which involve the design, development, production, use or stockpiling of nuclear, chemical or biological weapons or missiles, nor shall they use Bourns® products or technology in any facility which engages in activities relating to such devices. The foregoing restrictions apply to all uses and applications that violate national or international prohibitions, including embargos or international regulations. Further, Bourns® products and Bourns technology and technical data may not under any circumstance be exported or re-exported to countries subject to international sanctions or embargoes. Bourns® products may not, without prior authorization from Bourns and/or the U.S. Government, be resold, transferred, or re-exported to any party not eligible to receive U.S. commodities, software, and technical data.

To the maximum extent permitted by applicable law, Bourns disclaims (i) any and all liability for special, punitive, consequential, incidental or indirect damages or lost revenues or lost profits, and (ii) any and all implied warranties, including implied warranties of fitness for particular purpose, non-infringement and merchantability.

For your convenience, copies of this Legal Disclaimer Notice with German, Spanish, Japanese, Traditional Chinese and Simplified Chinese bilingual versions are available at:

Web Page: <http://www.bourns.com/legal/disclaimers-terms-and-policies>

PDF: <http://www.bourns.com/docs/Legal/disclaimer.pdf>