

Features

- RoHS compliant*
- Glass passivated chip
- Low reverse leakage current
- Low forward voltage drop
- High current capability



This series is obsolete and not recommended for new designs. [Recommended replacement products](#) are available.

CD214A-R150~R12000 Glass Passivated Rectifiers

General Information

The markets of portable communications, computing and video equipment are challenging the semiconductor industry to develop increasingly smaller electronic components. Bourns offers Glass Passivated Rectifiers for rectification applications, in compact chip DO-214AC (SMA) size format, which offer PCB real estate savings and are considerably smaller than most competitive parts. The Glass Passivated Rectifier Diodes offer a forward current of 1 A with a choice of repetitive peak reverse voltage of 50 V up to 2000 V.

Bourns® Chip Diodes conform to JEDEC standards, are easy to handle on standard pick and place equipment and their flat configuration minimizes roll away.

Electrical Characteristics (@ T_A = 25 °C Unless Otherwise Noted)

Parameter	Symbol	CD214A-					Unit
		R150	R1100	R1200	R1400	R1600	
Maximum Repetitive Peak Reverse Voltage	V _{RRM}	50	100	200	400	600	V
Maximum RMS Voltage	V _{RMS}	35	70	140	280	420	V
Maximum DC Blocking Voltage	V _{DC}	50	100	200	400	600	V
Max. Average Forward Rectified Current ¹	I _(AV)	1.0					A
DC Reverse Current @ Rated DC Blocking Voltage (@T _J = 25 °C)	I _R	5.0					µA
DC Reverse Current @ Rated DC Blocking Voltage (@T _J = 125 °C)	I _R	30					µA
DC Reverse Current @ Rated DC Blocking Voltage (@T _J = 150 °C)	I _R	50					µA
Typical Junction Capacitance ²	C _J	12					pF
Maximum Instantaneous Forward Voltage @ 1 A	V _F	1.0					V
Typical Thermal Resistance ³	R _{θJA} R _{θJL}	75 27					°C/W °C/W
Peak forward surge current 8.3 ms single half sine-wave superimposed on rated load (JEDEC Method)	I _{FSM}	30					A

Notes:

1 See Forward Derating Curve.

2 Measured @ 1.0 MHz and applied reverse voltage of 4.0 VDC.

3 Thermal resistance from junction to ambient and from junction to lead P.C.B. mounted on 0.2 x 0.2 (5.0 mm x 5.0 mm) copper pad areas.



WARNING Cancer and Reproductive Harm - www.P65Warnings.ca.gov

*RoHS Directive 2015/863, Mar 31, 2015 and Annex.

Specifications are subject to change without notice.

Users should verify actual device performance in their specific applications.

The products described herein and this document are subject to specific legal disclaimers as set forth on the last page of this document, and at www.bourns.com/docs/legal/disclaimer.pdf.

CD214A-R150~R12000 Glass Passivated Rectifiers

BOURNS®

Electrical Characteristics (@ $T_A = 25\text{ °C}$ Unless Otherwise Noted)

Parameter	Symbol	CD214A-						Unit
		R1800	R11000	R11100	R11200	R11600	R12000	
Maximum Repetitive Peak Reverse Voltage	V_{RRM}	800	1000	1100	1200	1600	2000	V
Maximum RMS Voltage	V_{RMS}	560	700	770	840	1120	1400	V
Maximum DC Blocking Voltage	V_{DC}	800	1000	1100	1200	1600	2000	V
Max. Average Forward Rectified Current ¹	$I_{(AV)}$	1.0						A
DC Reverse Current @ Rated DC Blocking Voltage (@ $T_J = 25\text{ °C}$)	I_R	5.0						μA
DC Reverse Current @ Rated DC Blocking Voltage (@ $T_J = 125\text{ °C}$)	I_R	30		50				μA
Typ. Junction Capacitance ²	C_J	12						pF
Maximum Instantaneous Forward Voltage @ 1 A	V_F	1.0		1.25			2.0	V
Typical Thermal Resistance ³	$R_{\theta JA}$	75						$^{\circ}\text{C/W}$
	$R_{\theta JL}$	27						$^{\circ}\text{C/W}$
Peak forward surge current 8.3 ms single half sine-wave superimposed on rated load (JEDEC Method)	I_{FSM}	30		25			30	A

Notes:

- 1 See Forward Derating Curve.
- 2 Measured @ 1.0 MHz and applied reverse voltage of 4.0 VDC.
- 3 Thermal resistance from junction to ambient and from junction to lead P.C.B. mounted on 0.2" x 0.2" (5.0 mm x 5.0 mm) copper pad areas.

Thermal Characteristics (@ $T_A = 25\text{ °C}$ Unless Otherwise Noted)

Parameter	Symbol	CD214A-R150~R12000	Unit
Operating Temperature Range	T_J	-65 to +175	$^{\circ}\text{C}$
Storage Temperature Range	T_{STG}	-65 to +175	$^{\circ}\text{C}$

Specifications are subject to change without notice.

Users should verify actual device performance in their specific applications.

The products described herein and this document are subject to specific legal disclaimers as set forth on the last page of this document, and at www.bourns.com/docs/legal/disclaimer.pdf.

CD214A-R150~R12000 Glass Passivated Rectifiers



Product Dimensions

This is an RoHS compliant molded plastic package. The polarity is indicated by a cathode band and weighs approximately 0.064 g. The package and dimensions are shown below.

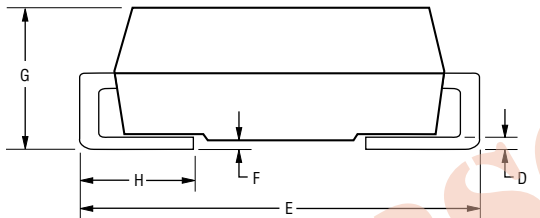
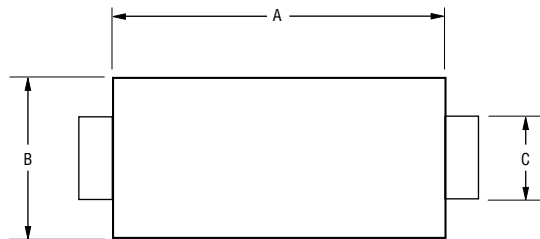

DIMENSIONS: $\frac{\text{MM}}{\text{(INCHES)}}$

Dimensions	DO-214AC (SMA)
A	$\frac{4.06 - 4.57}{(0.160 - 0.180)}$
B	$\frac{2.29 - 2.92}{(0.090 - 0.115)}$
C	$\frac{1.27 - 1.63}{(0.050 - 0.064)}$
D	$\frac{0.15 - 0.31}{(0.006 - 0.112)}$
E	$\frac{4.83 - 5.59}{(0.190 - 0.220)}$
F	$\frac{0.05 - 0.20}{(0.002 - 0.008)}$
G	$\frac{2.01 - 2.62}{(0.080 - 0.103)}$
H	$\frac{0.76 - 1.52}{(0.030 - 0.060)}$

Recommended Pad Layout

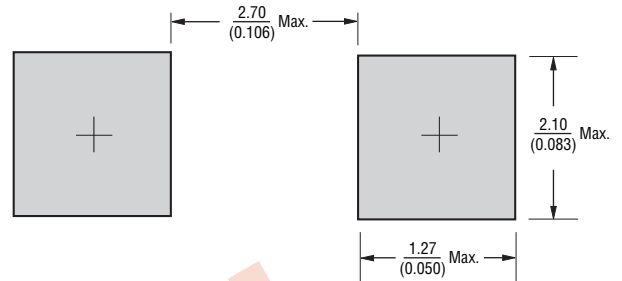

DIMENSIONS: $\frac{\text{MM}}{\text{(INCHES)}}$

Physical Specifications

CaseMolded plastic per UL Class 94V-0
 PolarityBand indicates diode cathode
 Weight0.002 ounces / 0.064 grams

How To Order

CD 214A - R 1 50

Common Code _____
 Chip Diode _____
 Package _____
 • 214A = SMA/DO-214AC
 Model _____
 R = Glass Passivated Rectifiers
 Forward Current I_{AV} _____
 1 = 1 A
 Reverse Voltage _____
 50 = 50 V 1000 = 1000 V
 100 = 100 V 1100 = 1100 V
 200 = 200 V 1200 = 1200 V
 400 = 400 V 1600 = 1600 V
 600 = 600 V 2000 = 2000 V
 800 = 800 V

Typical Part Marking

CD214A-R150	B R1A
CD214A-R1100	B R1B
CD214A-R1200	B R1D
CD214A-R1400	B R1G
CD214A-R1600	B R1J
CD214A-R1800	B R1K
CD214A-R11000	B R1M
CD214A-R11100	B R1N
CD214A-R11200	B R1Q
CD214A-R11600	B R1Y
CD214A-R12000	B R1Z

Specifications are subject to change without notice.

Users should verify actual device performance in their specific applications.

The products described herein and this document are subject to specific legal disclaimers as set forth on the last page of this document, and at www.bourns.com/docs/legal/disclaimer.pdf.

CD214A-R150~R12000 Glass Passivated Rectifiers



Rating and Characteristic Curves

Forward Current Derating Curve

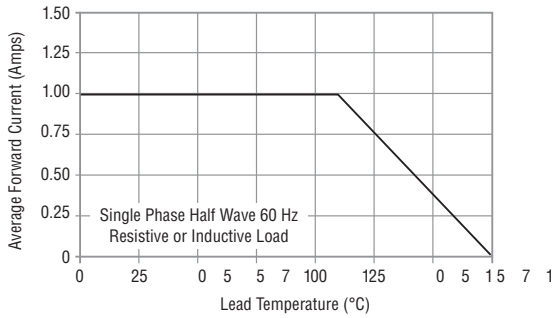

Non-Repetitive Surge Current

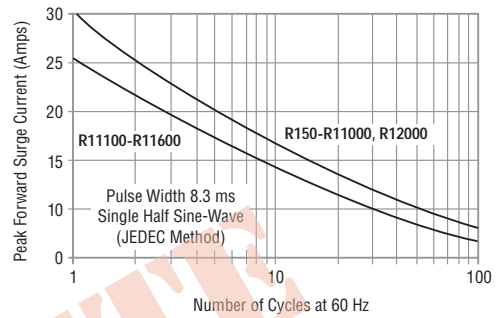

Forward Characteristics

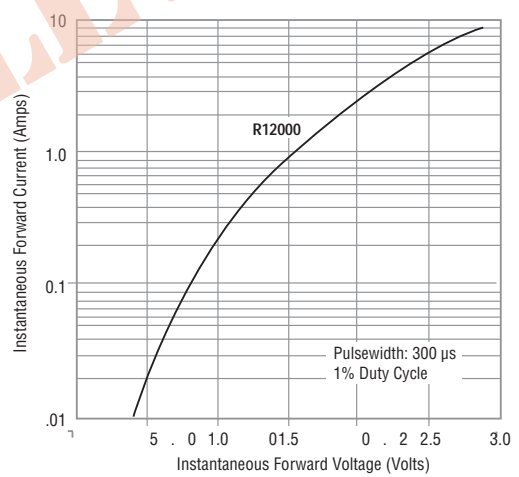
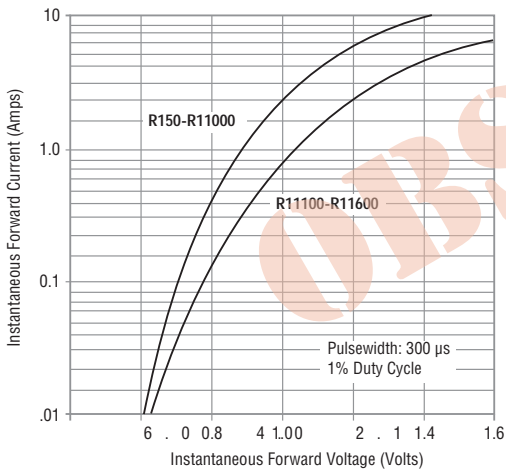

Reverse Characteristics

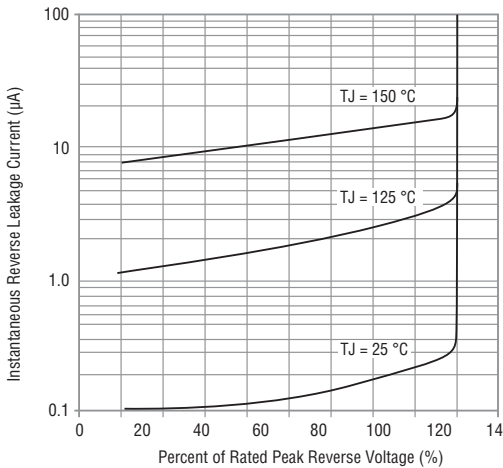

Specifications are subject to change without notice. Users should verify actual device performance in their specific applications. The products described herein and this document are subject to specific legal disclaimers as set forth on the last page of this document, and at www.bourns.com/docs/legal/disclaimer.pdf.

CD214A-R150~R12000 Glass Passivated Rectifiers

BOURNS®

Packaging Information

The surface mount product is packaged in a 12 mm x 4 mm tape and reel format per EIA-481 standard.

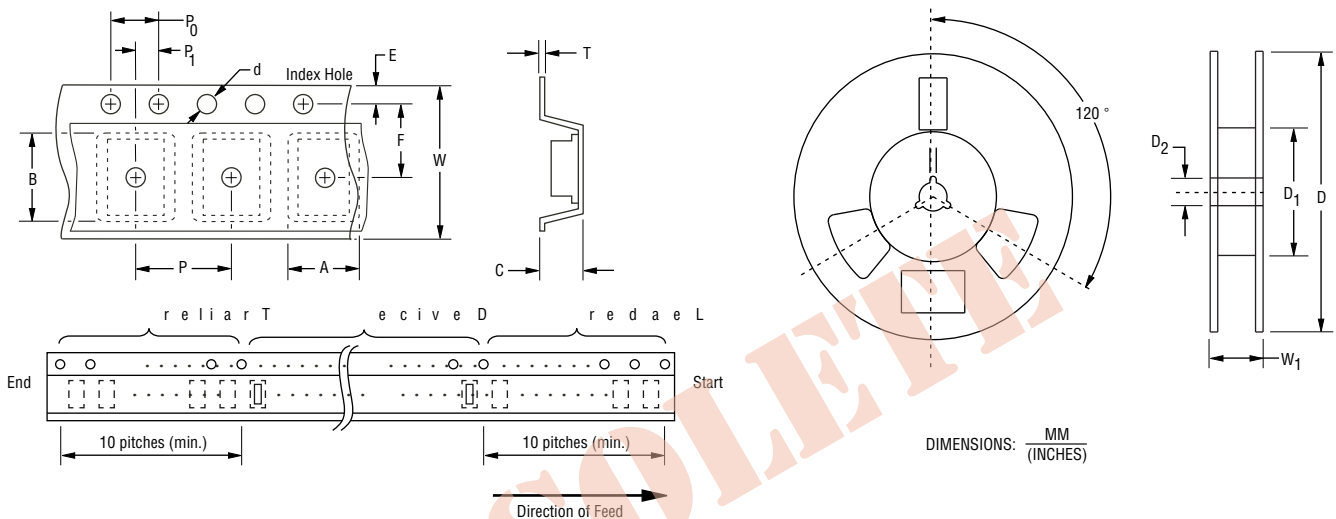

DIMENSIONS: $\frac{\text{MM}}{\text{(INCHES)}}$

Item	Symbol	DO-214AC (SMA)
Carrier Width	A	$\frac{3.42 \pm 0.10}{(0.134 \pm 0.004)}$
Carrier Length	B	$\frac{5.07 \pm 0.10}{(0.199 \pm 0.004)}$
Carrier Depth	C	$\frac{3.10 \pm 0.10}{(0.122 \pm 0.004)}$
Sprocket Hole	d	$\frac{1.55 \pm 0.05}{(0.061 \pm 0.002)}$
Reel Outside Diameter	D	$\frac{330}{(12.992)}$
Reel Inner Diameter	D ₁	$\frac{50.0}{(1.969)}$ Min.
Feed Hole Diameter	D ₂	$\frac{13.0 \pm 0.50}{(0.512 \pm 0.020)}$
Sprocket Hole Position	E	$\frac{1.75 \pm 0.10}{(0.069 \pm 0.004)}$
Punch Hole Position	F	$\frac{5.50 \pm 0.50}{(0.217 \pm 0.020)}$
Punch Hole Pitch	P	$\frac{4.00 \pm 0.10}{(0.157 \pm 0.004)}$
Sprocket Hole Pitch	P ₀	$\frac{4.00 \pm 0.10}{(0.157 \pm 0.004)}$
Embossment Center	P ₁	$\frac{2.00 \pm 0.05}{(0.079 \pm 0.002)}$
Overall Tape Thickness	T	$\frac{0.30 \pm 0.10}{(0.012 \pm 0.004)}$
Tape Width	W	$\frac{12.00 \pm 0.20}{(0.420 \pm 0.008)}$
Reel Width	W ₁	$\frac{18.7}{(0.736)}$ Max.
Quantity per Reel	—	7,500

BOURNS®

Asia-Pacific:

Tel: +886-2 2562-4117

Email: asiacus@bourns.com

Europe:

Tel: +36 88 885 877

Email: eurocus@bourns.com

The Americas:

Tel: +1-951 781-5500

Email: americus@bourns.com

www.bourns.com

REV. 06/21

Specifications are subject to change without notice.

Users should verify actual device performance in their specific applications.

The products described herein and this document are subject to specific legal

disclaimers as set forth on the last page of this document, and at

www.bourns.com/docs/legal/disclaimer.pdf.

This legal disclaimer applies to purchasers and users of Bourns® products manufactured by or on behalf of Bourns, Inc. and its affiliates (collectively, “Bourns”).

Unless otherwise expressly indicated in writing, Bourns® products and data sheets relating thereto are subject to change without notice. Users should check for and obtain the latest relevant information and verify that such information is current and complete before placing orders for Bourns® products.

The characteristics and parameters of a Bourns® product set forth in its data sheet are based on laboratory conditions, and statements regarding the suitability of products for certain types of applications are based on Bourns’ knowledge of typical requirements in generic applications. The characteristics and parameters of a Bourns® product in a user application may vary from the data sheet characteristics and parameters due to (i) the combination of the Bourns® product with other components in the user’s application, or (ii) the environment of the user application itself. The characteristics and parameters of a Bourns® product also can and do vary in different applications and actual performance may vary over time. Users should always verify the actual performance of the Bourns® product in their specific devices and applications, and make their own independent judgments regarding the amount of additional test margin to design into their device or application to compensate for differences between laboratory and real world conditions.

Unless Bourns has explicitly designated an individual Bourns® product as meeting the requirements of a particular industry standard (e.g., ISO/TS 16949) or a particular qualification (e.g., UL listed or recognized), Bourns is not responsible for any failure of an individual Bourns® product to meet the requirements of such industry standard or particular qualification. Users of Bourns® products are responsible for ensuring compliance with safety-related requirements and standards applicable to their devices or applications.

Bourns® products are not recommended, authorized or intended for use in nuclear, lifesaving, life-critical or life-sustaining applications, nor in any other applications where failure or malfunction may result in personal injury, death, or severe property or environmental damage. Unless expressly and specifically approved in writing by two authorized Bourns representatives on a case-by-case basis, use of any Bourns® products in such unauthorized applications might not be safe and thus is at the user’s sole risk. Life-critical applications include devices identified by the U.S. Food and Drug Administration as Class III devices and generally equivalent classifications outside of the United States.

Bourns expressly identifies those Bourns® standard products that are suitable for use in automotive applications on such products’ data sheets in the section entitled “Applications.” Unless expressly and specifically approved in writing by two authorized Bourns representatives on a case-by-case basis, use of any other Bourns® standard products in an automotive application might not be safe and thus is not recommended, authorized or intended and is at the user’s sole risk. If Bourns expressly identifies a sub-category of automotive application in the data sheet for its standard products (such as infotainment or lighting), such identification means that Bourns has reviewed its standard product and has determined that if such Bourns® standard product is considered for potential use in automotive applications, it should only be used in such sub-category of automotive applications. Any reference to Bourns® standard product in the data sheet as compliant with the AEC-Q standard or “automotive grade” does not by itself mean that Bourns has approved such product for use in an automotive application.

Bourns® standard products are not tested to comply with United States Federal Aviation Administration standards generally or any other generally equivalent governmental organization standard applicable to products designed or manufactured for use in aircraft or space applications. Bourns expressly identifies Bourns® standard products that are suitable for use in aircraft or space applications on such products’ data sheets in the section entitled “Applications.” Unless expressly and specifically approved in writing by two authorized Bourns representatives on a case-by-case basis, use of any other Bourns® standard product in an aircraft or space application might not be safe and thus is not recommended, authorized or intended and is at the user’s sole risk.

The use and level of testing applicable to Bourns® custom products shall be negotiated on a case-by-case basis by Bourns and the user for which such Bourns® custom products are specially designed. Absent a written agreement between Bourns and the user regarding the use and level of such testing, the above provisions applicable to Bourns® standard products shall also apply to such Bourns® custom products.

Users shall not sell, transfer, export or re-export any Bourns® products or technology for use in activities which involve the design, development, production, use or stockpiling of nuclear, chemical or biological weapons or missiles, nor shall they use Bourns® products or technology in any facility which engages in activities relating to such devices. The foregoing restrictions apply to all uses and applications that violate national or international prohibitions, including embargos or international regulations. Further, Bourns® products and Bourns technology and technical data may not under any circumstance be exported or re-exported to countries subject to international sanctions or embargoes. Bourns® products may not, without prior authorization from Bourns and/or the U.S. Government, be resold, transferred, or re-exported to any party not eligible to receive U.S. commodities, software, and technical data.

To the maximum extent permitted by applicable law, Bourns disclaims (i) any and all liability for special, punitive, consequential, incidental or indirect damages or lost revenues or lost profits, and (ii) any and all implied warranties, including implied warranties of fitness for particular purpose, non-infringement and merchantability.

For your convenience, copies of this Legal Disclaimer Notice with German, Spanish, Japanese, Traditional Chinese and Simplified Chinese bilingual versions are available at:

Web Page: <http://www.bourns.com/legal/disclaimers-terms-and-policies>

PDF: <http://www.bourns.com/docs/Legal/disclaimer.pdf>