

Polymeric Positive Temperature Coefficients (PPTCs) for Current Limit Control in Power Supplies to Reduce Power and Cost

APPLICATION NOTE



INTRODUCTION

Modern Switch Mode Power Supplies (SMPS) are used for powering electronic functions such as logic, motor drives or battery chargers across all segments. At the heart of the SMPS is a controller chip, which drives a power MOSFET (internal to the chip or external). In order to protect the MOSFET from damage, all chips use internal overcurrent protection. The peak current (also known as current limit) that triggers the overcurrent protection varies from controller chip to controller chip. Due to this variation, a power supply could deliver up to several times what is actually written in the specification. This means that designers must use larger and more expensive inductors to avoid saturation of the magnetics in case the output power reaches the upper limit before the overcurrent protection begins. This also implies a higher cost in terms of components and additional board space.

This application note demonstrates a simple way to tighten the current limit, allowing smaller, and therefore, less expensive inductors using a Polymeric PTC thermistor or PPTC. PPTCs are comprised of a low resistance material combined with non-conductive polymers. The PPTC has quite a sharp resistance versus temperature curve. Once the temperature caused by I^2R heating and ambient factors causes the polymer material to reach an amorphous state, the resistance will increase rapidly. The time it takes to reach the amorphous state depends on the rate of rise of the polymer temperature.

Figure 1 shows the typical resistance temperature curve of the Bourns® Multifuse® standard grade PPTCs (red) and high temperature PPTCs (blue). High temperature Bourns® Multifuse® PPTCs are derated at operating temperatures of up to 125 °C. The high temperature material is useful in appliance applications which operate at up to 85 °C, as well as automotive applications that operate at ambient temperatures up to 100 °C.

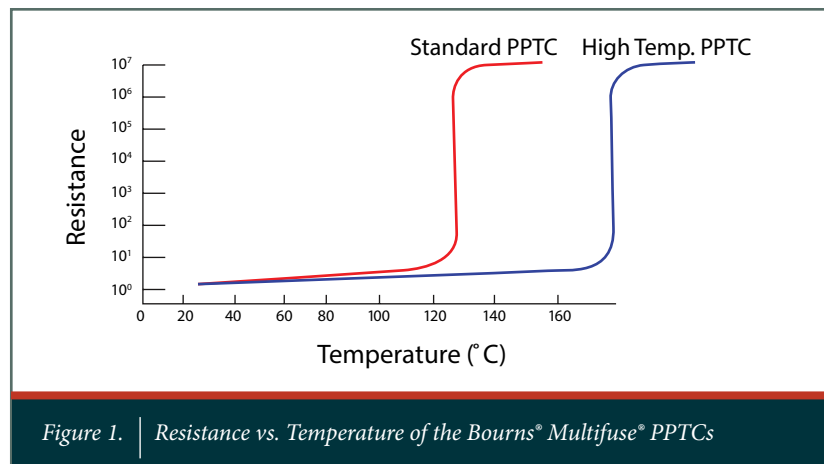

Figure 1. Resistance vs. Temperature of the Bourns® Multifuse® PPTCs

Polymeric Positive Temperature Coefficients (PPTCs) for Current Limit Control in Power Supplies to Reduce Power and Cost



DEMONSTRATION OF POWER SUPPLY WITH PPTC

The schematic as shown in figure 2a was built and tested to evaluate whether a PPTC could implement a current limit lower than the internal overcurrent protection in the controller chip itself. The power supply is a buck converter operating at a frequency of 100 kHz with an output of 50 mA at 5.3 VDC. The voltage across L1 was measured using an oscilloscope and the waveform is shown in figure 3. The integral of the voltage over a complete cycle is always equal to zero which explains the positive and negative voltage.

$$\frac{1}{T_s} \int_0^{DT_s} (V_g - V) dt + \frac{1}{T_s} \int_{DT_s}^{T_s} -V dt = 0: \text{Equation 1}$$

The controller chip had a current limit range of between 0.55 A and 1.0 A with a nominal value of 0. Using this equation, the specification for a power supply can, therefore, meet a constant power with a peak current of 0.55 A. To calculate the output power, the following formula can be used:

$$P_{out} = V_{out} \cdot I_{peak} \sqrt{\frac{D}{3}}: \text{Equation 2}$$

As a result, taking the values listed below calculates the specification to be 1.2 watts.

- A. $V_{out} = 5.3 \text{ V}$
- B. $I_{peak} = 0.55 \text{ A}$
- C. Duty cycle $D = 0.5$

This is the power which a designer can be confident of achieving without being limited by the overcurrent protection. However, given the tolerance of the current limit and changing the value of I_{peak} in the previous formula, the power supply could in theory deliver up to 2.2 watts (twice the specification) before the overcurrent protection functions. Therefore, the inductor must be able to handle the higher peak currents that could occur.

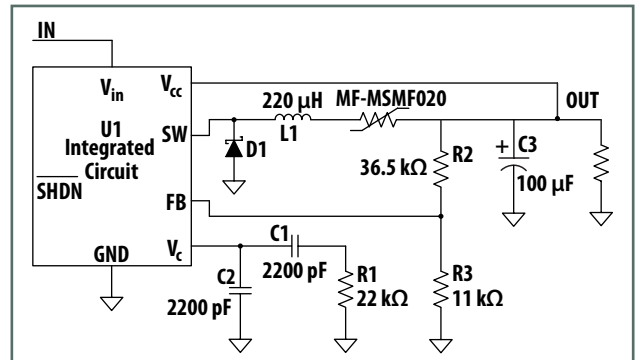

Figure 2a. Buck Converter Circuit Diagram

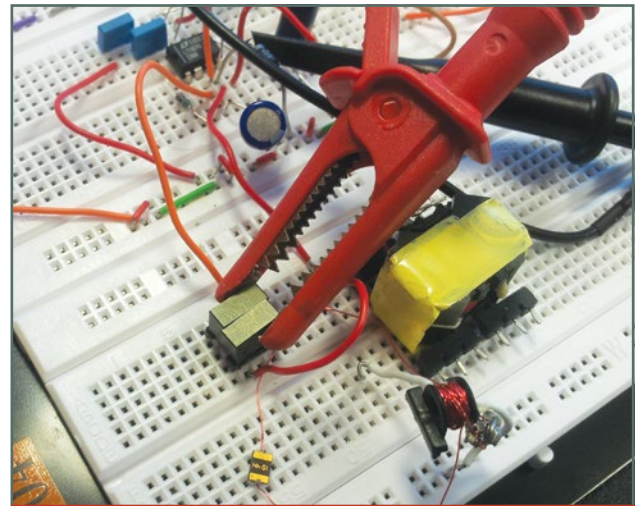

Figure 2b. Photo of Buck Converter Built and Tested for this Application Note

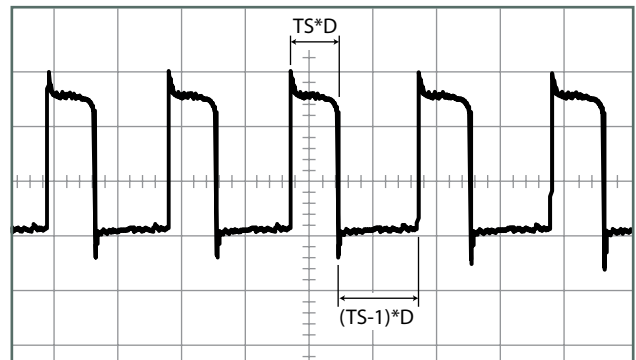

Figure 3. Voltage Across L1 During Normal Operation

Polymeric Positive Temperature Coefficients (PPTCs) for Current Limit Control in Power Supplies to Reduce Power and Cost



DEMONSTRATION OF POWER SUPPLY WITH PPTC (Continued)

The dimensions of the inductor depend on the maximum value of current in amps which will pass through it. The core area is derived from equation 3 below:

$$B.A.N. = \int_{I_{min}}^{I_{max}} L di: \text{Equation 3}$$

In the example application, the controller has the following peak current limit values:

- Upper limit: 1.0 A
- Average: 0.7 A
- Lower limit: 0.55 A

An inductor would require the following characteristics to be able to cope with maximum output of 2.2 watts.

- Inductance: 220 μ H
- Number of turns: 20
- Peak current: 1.0 A
- Saturation flux density: 0.35 T

Therefore, using equation 3, the minimum core area must be $(L.I)/(B.N) = 14 \text{ mm}^2$. An EP13 core with a minimum surface area of 14.9 mm^2 could be used.

However, if the peak current was reduced from 1.0 A to 0.25 A, then the minimum core area needed would now be 3.5 mm^2 or a factor of 4.0. Such a large reduction in core area would lead to a huge reduction in the inductor's footprint. This in turn leads to cost-savings in terms of the inductor itself and the printed circuit board cost. An inductor using an EP7 core was built for this experiment. EP7 cores have a surface area of 10 mm^2 . This inductor would have a peak current of 0.7 A. Hence, this is well below the minimum required for the controller with the existing current limit.

Placing a PPTC that is selected to trip at the right current under the right conditions on the output of the controller chip enables the use of the smaller inductor. By selecting the right model, the PPTC will trip before the inductor saturates. Saturation causes a reduction in output power as well as overheating of the coil due to very high current. If the temperature exceeds the insulation rating then the inductor may emit smoke and fail.

Polymeric Positive Temperature Coefficients (PPTCs) for Current Limit Control in Power Supplies to Reduce Power and Cost



DEMONSTRATION OF POWER SUPPLY WITH PPTC (Continued)

Figure 2 shows an 1812-sized (4.5 x 3.0 mm) PPTC (Bourns® Model MF-MSMF010) placed in series after the inductor. This PPTC has a hold current of 100 mA and a trip current of 300 mA which is the current at which the PPTC is designed to trip. The resistance of the PPTC will tend to increase after it has been reflow soldered onto a board (referred to as $R1_{max}$ on the datasheet). The resistance of the PPTC on the board had increased from 0.7 ohms prior to soldering to 2 ohms post soldering. The extra heating effect (I^2R) created by the increase in resistance pushes the trip current from 300 mA closer to 100 mA.

In the case of the experimental power supply built for this application note, the PPTC tripped within 10 seconds when the current was ramped up to 107 mA. This current corresponds to a peak current of 267 mA in the inductor which is below the peak current of 0.7 A allowed by an EP7 core. The inductor was, therefore, operating well below saturation.

The capacitor discharged, causing the output voltage to drop and the supply voltage to the controller chip to drop. The drop in feedback caused the switch to be kept on by the controller. Figure 5 shows short negative voltage drops across the inductor which is necessary to balance equation 1. Recycling the power causes the Multiuse® PPTC device to reset.

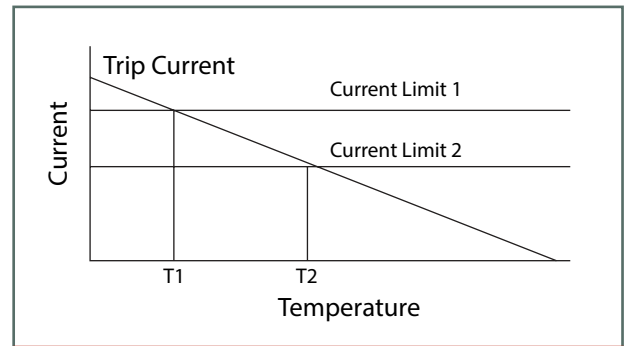

Figure 4. | Graph Illustrating the Relationship Between Trip Current and Temperature

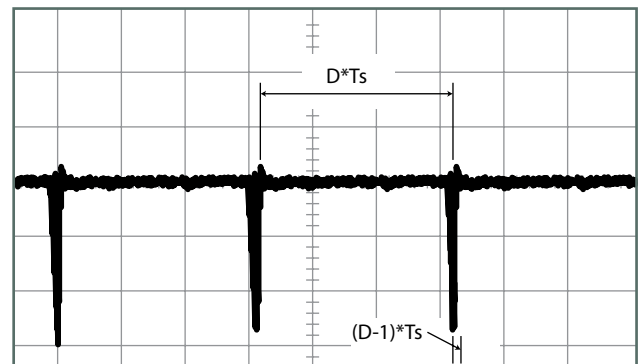

Figure 5. | Voltage Across Inductor when the Multifuse® PPTC Device Trips

Polymeric Positive Temperature Coefficients (PPTCs) for Current Limit Control in Power Supplies to Reduce Power and Cost



TYPICAL APPLICATIONS

Anyone who is designing a power supply and wants to reduce the footprint taken up by power magnetics on the board can use this method. One example is an appliance application, where circuits which are classified as “low power” per IEC 60335-1, with less stringent testing and approval requirements. For that reason, an appliance company may desire to qualify a power supply as being “low power” for speed of design and lower cost of agency approvals. The same concept of using a PPTC to reduce the current limit of a power supply can be used here to ensure conformance with the low power specification. This also applies to clusters of circuits on a board which need to be certified as complying with “low power”.

Another pertinent example is for designers who need to reduce board space in a low-power power supply in an automotive application. The circuit could have multiple outputs where one output is matched to the peak current of the overcurrent protection controller and the remaining outputs require inductors sized to the peak current of the first output even if the power requirements are much lower. The voltage rating of the PPTC is also important here. From equation 1, the voltage across the PPTC will be the peak input voltage minus the output voltage over one cycle. Therefore, if the specification has a wide input range the voltage rating of the PPTC must be taken into consideration.

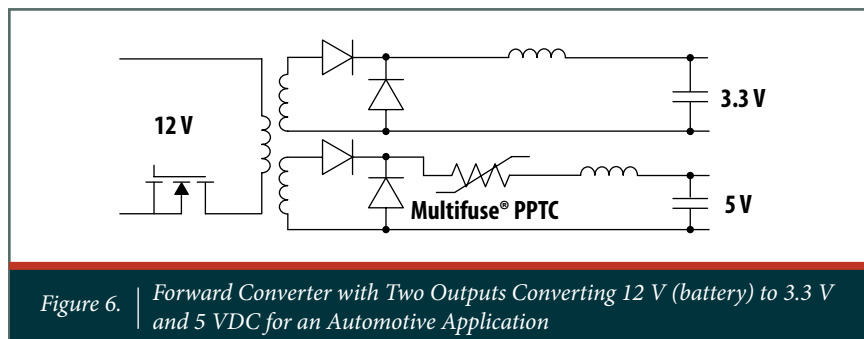

Satisfying the needs of current limit control in power supplies, Bourns offers a range of high temperature PPTCs in its product line featuring operating currents of 0.39 A to 7.2 A at 85 °C and DC voltages up to 16 V. Surface mount and through-hole versions are available as standard options. Applications such as consumer appliances or automotive electronics, which have 85 °C as the typical operating temperatures can use Bourns® high temperature PPTCs for current limiting applications. The Bourns® Multifuse® PPTC Resettable Fuse production line is ISO TS16949 certified and Bourns is able to produce AEC-Q200 test reports for all products upon request.

Polymeric Positive Temperature Coefficients (PPTCs) for Current Limit Control in Power Supplies to Reduce Power and Cost



CONCLUSION

Power inductors typically are oversized for the application due to the tolerances of the maximum current allowed by the overcurrent protection circuit. If the tolerance is 20 % a power supply could deliver up to four times what is in the specification.

This application note shows some results taken when a buck converter with a current limit of 0.55 A was modified using a resettable PPTC to a buck converter with a current limit of 100 mA. The original core area of 14.7 mm² was reduced to 10 mm² and it was shown that in theory it could be reduced even further to 1.8 mm². It also gives the designer more flexibility. The designer can use a common platform based around one controller chip and can modify the current limit as required. This should be a time and cost savings for the designer. The wide operating temperature range of a Bourns® Multifuse® PPTC device enables this technology to be used in a broad range of appliance and automotive power supply applications.

ADDITIONAL RESOURCES

Please contact your local Bourns Application Engineer or Bourns Sales Representative for additional information.

Visit Bourns online at:

www.bourns.com

COPYRIGHT © 2015 • BOURNS, INC. • 01/15 • e/K1467

"Bourns" and "Multifuse" are registered trademarks of Bourns, Inc. in the U.S. and other countries.