



# Automotive Grade Fuses Provide Overcurrent Protection in Certain Harsh Environment Applications

## WHITE PAPER



Bourns® SF-0603SA-M Series



Bourns® SF-0603HIA-M Series



Bourns® SF-1206SA-M Series



Bourns® SF-1206HIA-M Series



Bourns® SF-1206SA-W Series

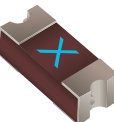

Bourns® SF-2410FPA-W Series

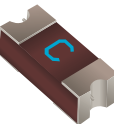

Bourns® SF-2410FA-W Series

### INTRODUCTION

As electronic systems and applications have become more interdependent, overcurrent faults must be quickly isolated to prevent damage to adjacent circuits and systems. At the same time, nuisance tripping due to ambient temperature, inrush current or other events that pose no risk to the system must be minimized to ensure the integrated system stays online. Connected next-generation applications such as IoT and smart sensor-based designs can be particularly vulnerable to overcurrent events that lead to failure of one or more devices, resulting in the reduced reliability of the network.

Many of these highly integrated and interdependent applications are systems that operate in severe environments, making circuit protection an important part of these designs so as to help maintain reliability. A primary example is the integrated electronics in automotive designs, which are subjected to wide temperature variations, shock and vibration, humidity and other harmful conditions. Stringent automotive reliability standards for new vehicle applications such as engine controls, battery management systems (BMS), comfort/convenience features, and infotainment require overcurrent protection to help meet these specifications.

Advancements engineered into new surface mount (SMD) fuses are able to address the growing need for effective overcurrent protection in an increasing range of applications that must operate in harsh environmental conditions. In particular, new AEC-200 equivalent compliant fuses provide the rugged performance and features that offer designers an extra level of performance and operation in higher stress applications.

# Automotive Grade Fuses Provide Overcurrent Protection in Certain Harsh Environment Applications



Bourns® SF-0603SA-M Series



Bourns® SF-0603HIA-M Series



Bourns® SF-1206SA-M Series



Bourns® SF-1206HIA-M Series



Bourns® SF-1206SA-W Series

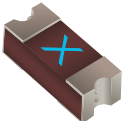

Bourns® SF-2410FPA-W Series

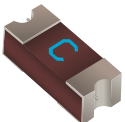

Bourns® SF-2410FA-W Series

## WHERE AUTOMOTIVE GRADE FUSES MAKE A DIFFERENCE

Automotive designs have more embedded electronics than ever before. Along with the rapid growth predicted in the electric vehicle (EV) market, circuit protection solutions must advance to meet a growing list of dynamic design requirements. According to research firm Research and Markets, the global hybrid and electric vehicle fuse market will grow at a CAGR of over 23 percent from 2018-2022. One major factor that is influencing this market growth is the increasing number of electronic components used in hybrid and electric vehicles, and the corresponding increase in the number of potential fault conditions. As electrification in the automotive sector continues to rise, so will the need for high reliability automotive grade fuses.

The increase in possible fault conditions in today's more electrified automotive applications has prompted designers of high energy storage systems to look for circuit protection components that are able to protect multiple elements of the design. Within the BMS, overcurrent protection is necessary for the main control power input, slave control monitor lines and cell balance lines as well as in the battery module and connection board.

Many designs rely on resettable devices for overcurrent threats caused by a transitory fault condition. To protect against fault currents that can cause serious circuit or system damage, non-resettable fuses are an excellent choice. The trend to make all embedded electronics smaller while adding more features has led to an increased demand for space-saving SMD fuses that can be easily mounted to a PCB.



## Automotive Grade Fuses Provide Overcurrent Protection in Certain Harsh Environment Applications



Bourns® SF-0603SA-M Series



Bourns® SF-0603HIA-M Series



Bourns® SF-1206SA-M Series



Bourns® SF-1206HIA-M Series



Bourns® SF-1206SA-W Series

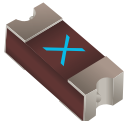

Bourns® SF-2410FPA-W Series

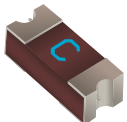

Bourns® SF-2410FA-W Series

### PROTECTION BY DESIGN

Fuses such as Bourns® SinglFuse™ SMD fuses work to protect a load based on the current flowing through the fuse. The fuse will trip when its rated parameters are exceeded. As a single blow fuse, Bourns® SinglFuse™ SMD fuses become a true open circuit when the device trips, allowing no current to flow through to downstream components on the other side of the surge.

The SinglFuse™ SF-0603SA-M, SF-0603HIA-M, SF-1206SA-M and SF-1206HIA-M model families were developed using Bourns' advanced multilayer ceramic design that enables enhanced voltage and current handling capabilities. Offered in small 0603 and 1206 package sizes, these models feature high inrush current withstand capabilities and slow-blow fusing speeds.

To reliably withstand a surge within the device's rated specifications, the construction of an SMD fuse is important. Utilizing Bourns' innovative PCB wire core and ceramic multilayer designs, the latest AEC-200 equivalent compliant model families deliver enhanced voltage and current handling capabilities, with more precise hot spot control along the fuse element. They also provide improved arcing suppression and inrush current withstand capability, and superior structural integrity when blown compared to traditional ceramic tube fuse designs. Furthermore, their precision fusing characteristics also permit easy customization, allowing designers to meet application-specific fusing requirements.



## Automotive Grade Fuses Provide Overcurrent Protection in Certain Harsh Environment Applications

### SELECTING THE RIGHT FUSE

Since it is common for automotive applications to experience start-up pulses, designers typically specify fuses for automotive designs based on their inrush current withstand requirements. Most designs require fuses with enhanced inrush withstand capabilities so the fuses can weather inrush conditions without nuisance tripping and still protect against unwanted sustained overcurrent conditions. It is also important to consider the expected duration of a condition when specifying the fuse type.

When selecting an automotive grade fuse, current and voltage ratings and fusing speed are also important considerations. Bourns' automotive grade SMD fuse portfolio currently offers rated currents from 0.5 A to 20 A, with a wide range of rated voltages from 24 V to 250 V. Available package sizes currently range from EIA 2410 down to 0603, with models available in four different fusing speed options including fast acting, fast acting precision, slow blow, and high inrush withstand.

It is important not to use a slow-blow fuse as a replacement where a fast acting fuse was specified since a slow blow fuse may not open fast enough to protect sensitive electronics from an overcurrent condition.

Product safety standards such as UL now require overcurrent protection for battery-powered instruments, their associated chargers and power supplies. Providing secondary overcurrent protection, SinglFuse™ SMD fuses offer numerous advantages to many consumer electronics products.

New Bourns® SinglFuse™ models are AEC-200 equivalent compliant making them ideal protection solutions for certain harsh environment applications. The seven new model families are fully compliant with Bourns' internal AEC-Q200 equivalent test procedures to help ensure rugged performance in a broad variety of high stress applications.



Bourns® SF-0603SA-M Series



Bourns® SF-0603HIA-M Series



Bourns® SF-1206SA-M Series



Bourns® SF-1206HIA-M Series



Bourns® SF-1206SA-W Series

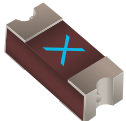

Bourns® SF-2410FPA-W Series

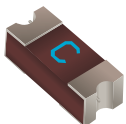

Bourns® SF-2410FA-W Series

# Automotive Grade Fuses Provide Overcurrent Protection in Certain Harsh Environment Applications

## WHAT IT MEANS TO BE AUTOMOTIVE GRADE

Designed and developed to meet certain criteria, Bourns automotive grade standard components are manufactured in facilities that are fully certified to IATF 16949. They also must have been tested and qualified using the AEC-Q product validation standard for passive components and presented to the customer for selection and approval using PPAP.

- Compliance with the latest applicable AEC-Q200, AEC-Q101 or AEC-Q102 product validation standard or its equivalent as determined by Bourns.

Note: Testing for AEC-Q200 compliance for one-time SMD fuses is still in standards development. However, Bourns has developed what Bourns believes is an equivalent test procedure for its fuse products to meet the strict automotive design specifications.

- New product and new process development meets or exceeds the requirements established in the latest AIAG revision of the Advanced Product Quality Planning (APQP) process. Bourns' design review process may be used if the Bourns quality and design engineering teams have established that the Bourns® standard component meets or exceeds the requirements of the APQP process.
- The manufacturing facility(ies) has a VDA 6.3 process audit score greater than 80 % with no downgrades.
- The manufacturing site must be certified to IATF 16949.



Bourns® SF-0603SA-M Series



Bourns® SF-0603HIA-M Series



Bourns® SF-1206SA-M Series



Bourns® SF-1206HIA-M Series

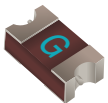

Bourns® SF-1206SA-W Series

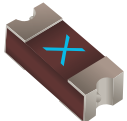

Bourns® SF-2410FPA-W Series

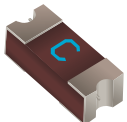

Bourns® SF-2410FA-W Series

# Automotive Grade Fuses Provide Overcurrent Protection in Certain Harsh Environment Applications

## APPLICATION EXAMPLES

The following application examples illustrate how designers can employ Bourns® SinglFuse™ SMD fuses with various voltage and current ratings and fusing speeds to meet specific protection requirements.

## USB I/O Ports

Designed to offer optimized voltage and current ratings for automotive systems that utilize DC/DC converters such as 48 V - 12 V, specific Bourns® SinglFuse™ models provide the necessary fusing speeds to support USB I/O port protection.

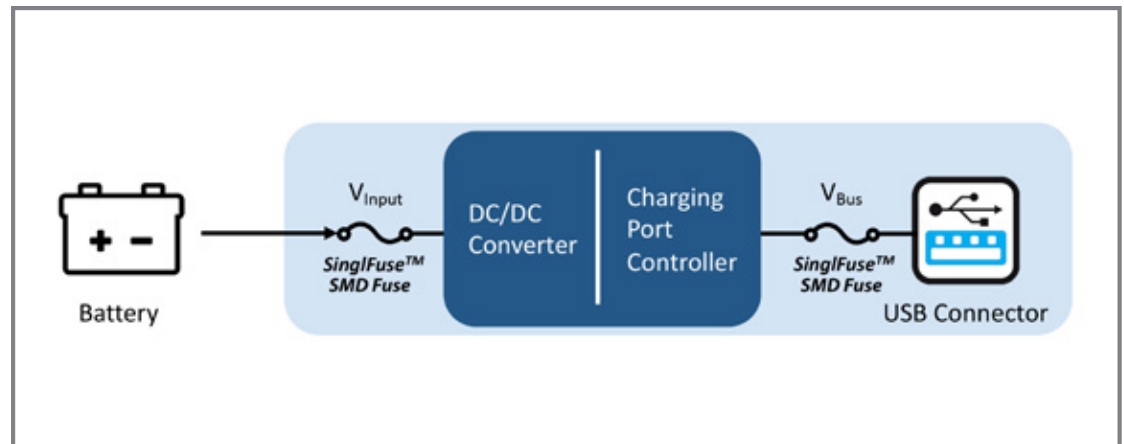

Bourns® SF-0603SA-M Series



Bourns® SF-0603HIA-M Series



Bourns® SF-1206SA-M Series



Bourns® SF-1206HIA-M Series

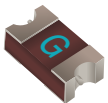

Bourns® SF-1206SA-W Series

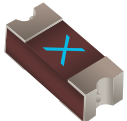

Bourns® SF-2410FPA-W Series

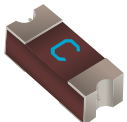

Bourns® SF-2410FA-W Series

# Automotive Grade Fuses Provide Overcurrent Protection in Certain Harsh Environment Applications

## APPLICATION EXAMPLES (Continued)

### On-Board Chargers

For On-Board Charger (OBC) applications, a SinglFuse™ SMD fuse can be used as primary overcurrent protection between the power grid and the DC-DC converter.

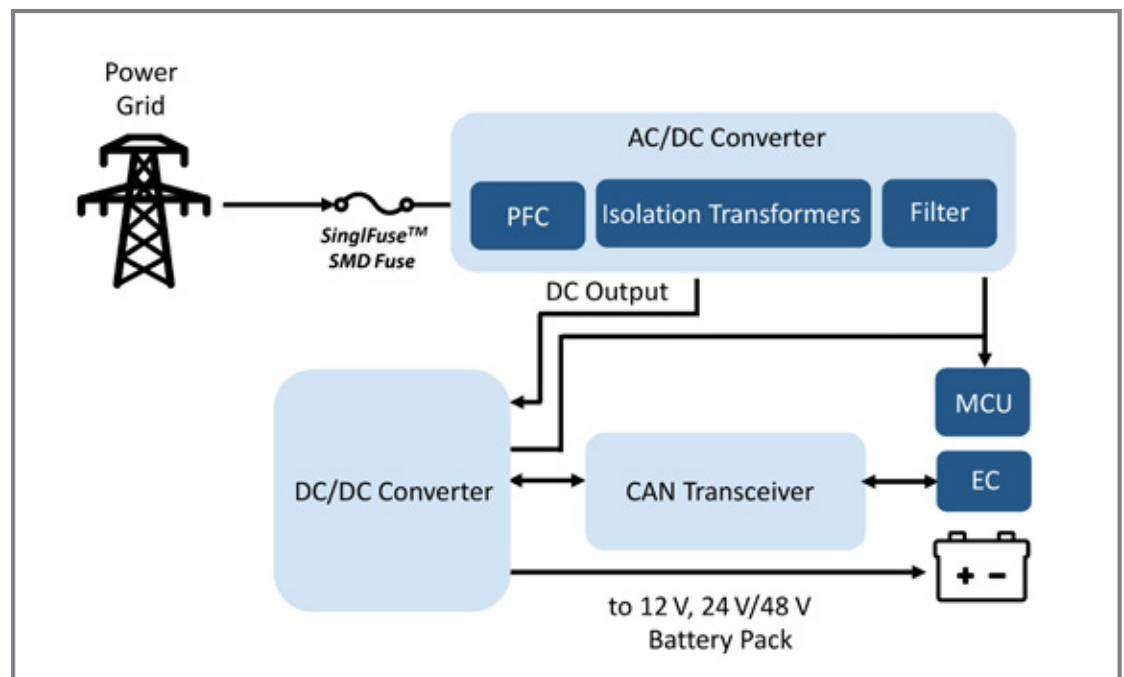

Bourns® SF-0603SA-M Series



Bourns® SF-0603HIA-M Series



Bourns® SF-1206SA-M Series



Bourns® SF-1206HIA-M Series



Bourns® SF-1206SA-W Series

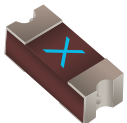

Bourns® SF-2410FPA-W Series

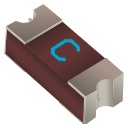

Bourns® SF-2410FA-W Series

# Automotive Grade Fuses Provide Overcurrent Protection in Certain Harsh Environment Applications

## APPLICATION EXAMPLES (Continued)

### Battery Management Systems (BMS)

In Battery management systems, designers can utilize SinglFuse™ SMD fuses as both primary overcurrent protection on the BMS controller board and for battery cell overcurrent protection.

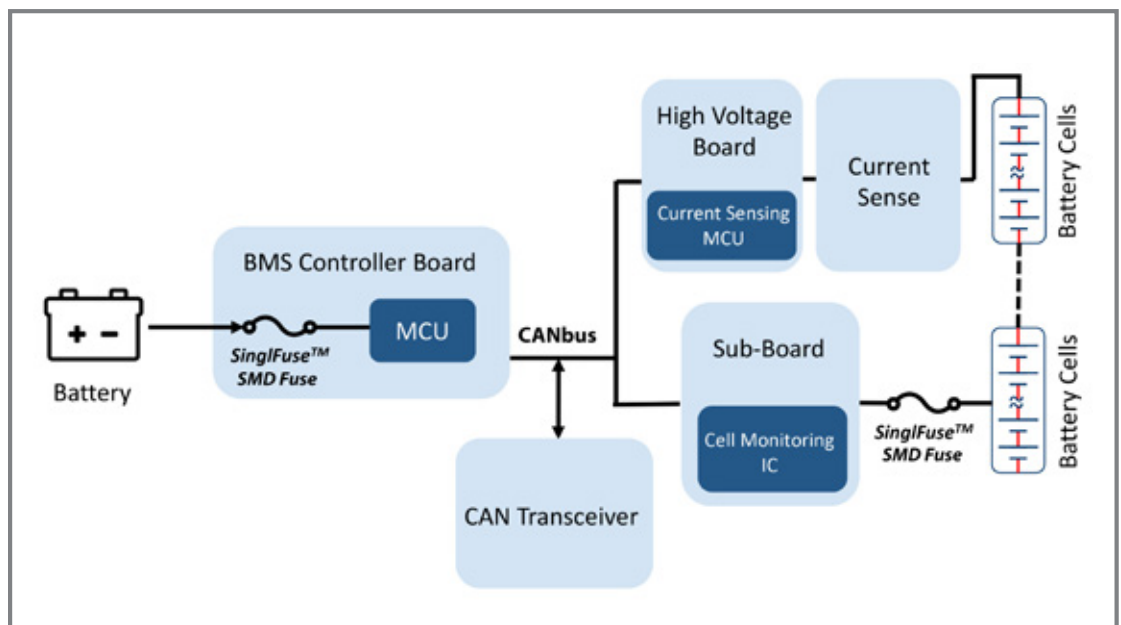

Bourns recommends that designers test all components, including SinglFuse™ SMD fuses and other overcurrent protection devices, for suitable performance in the designer's specific application.



Bourns® SF-0603SA-M Series



Bourns® SF-0603HIA-M Series



Bourns® SF-1206SA-M Series



Bourns® SF-1206HIA-M Series



Bourns® SF-1206SA-W Series

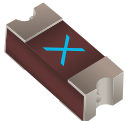

Bourns® SF-2410FPA-W Series

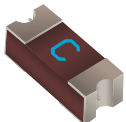

Bourns® SF-2410FA-W Series



# Automotive Grade Fuses Provide Overcurrent Protection in Certain Harsh Environment Applications

## MATCHING MORE THAN BATTERY SYSTEM NEEDS

With these new automotive grade fuses, Bourns continues to broaden its portfolio of SinglFuse™ SMD fuses to address the growing need for effective circuit protection in a variety of battery system applications. Because of their rugged design and wide temperature range operation, the latest automotive grade fuses from Bourns may also be suitable for a variety of applications including telecom and networking equipment, PCs and monitors, server farms, portable memory, portable electronics, gaming systems, robotics, smart appliances and industrial controllers, just to name a few.

In addition to the automotive grade fuses highlighted in this paper, Bourns continues to broaden its portfolio of fuse technologies allowing designers to select the right fuse for their application.



Bourns® SF-0603SA-M Series



Bourns® SF-0603HIA-M Series



Bourns® SF-1206SA-M Series



Bourns® SF-1206HIA-M Series



Bourns® SF-1206SA-W Series

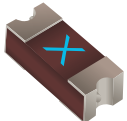

Bourns® SF-2410FPA-W Series

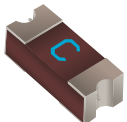

Bourns® SF-2410FA-W Series

[www.bourns.com](http://www.bourns.com)

**BOURNS®**

**Americas:** Tel +1-951 781-5500  
Email [americus@bourns.com](mailto:americus@bourns.com)

**EMEA:** Tel +36 88 885 877  
Email [eurocus@bourns.com](mailto:eurocus@bourns.com)

**Asia-Pacific:** Tel +886-2 256 241 17  
Email [asiacus@bourns.com](mailto:asiacus@bourns.com)

COPYRIGHT© 2021 • BOURNS, INC. • 6/21 • e/SF2109

"Bourns" is a registered trademark of Bourns, Inc. in the U.S. and other countries. "SinglFuse" is a trademark of Bourns, Inc.