

Application Note

Bourns® Trimpot® Trimming Potentiometers Interfacing with Surveillance System Sensors

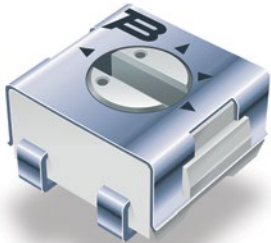

3313



3314

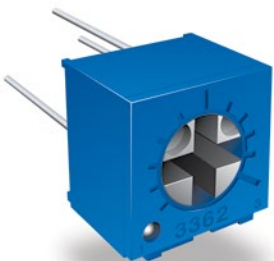

3362

Based upon advancements in available technologies and equipment, private citizens and businesses see value and peace-of-mind using security surveillance for their homes and offices. As such, security has become a multi-billion dollar market. Some surveillance systems are linked to an external security company or even directly to local law enforcement, so the sensors used in these systems must be accurate in order to avoid falsely alerting or misusing these resources. Each component in the design introduces accuracy and tolerance level variations. Given the accuracy requirements for security systems, it is crucial that the sensing circuitry operates within the desired sensitivity range when delivered to the customer and is available for adjustment upon installation or during service calls. A trimming potentiometer, also called a trimmer, is an effective way to satisfy the requirement to accurately adjust the sensor voltage level.

Bourns® Trimpot® Trimming Potentiometers and Surveillance System Primer

Trimmer technology is designed for use in applications where the unit must be calibrated before it is shipped to a retailer, and eventually the end user. Typically these pre-calibrated electronics use a trimmer for required adjustments to account for component variations over time. Medical and industrial designs frequently take advantage of the system calibration convenience of a trimmer. In surveillance systems, the trimmer is adjusted to obtain the best resolution of the sensors at an installation point.

The environmental conditions for surveillance systems can be quite varied. In sensors, the resistance range is rather tight, so even small changes can produce a noticeable effect on the sensitivity of the sensor. Additionally, the continual advancements in electronics and wireless technologies make it possible for a large range of sensors to be combined in a rather sophisticated and complex system, including wireless and motion sensors. Given the fact that the console may need to be accessed in any lighting situation, a light sensor is typically employed in consoles that feature a display so that the brightness of the display is appropriate for the operator. Regardless of the function, all sensors in the surveillance system are expected to be fully functional and maintain the integrity of the system at all times.

Trimmers in Action

Within the electronics of a surveillance system, a trimmer is incorporated in the interface to a sensor, and typically includes additional resistors. Because a trimmer is a passive component, it does not consume power, though it is important to limit the voltage at the trimmer to its rated voltage to avoid damaging the part. Current through the trimmer also must be limited to keep the power within the rated power range based on the voltage and operating temperature. Trimmers offer the greatest reliability when a sealed option is chosen to protect against prolonged exposure to various environmental factors such as dust or moisture.

To incorporate a trimmer into a surveillance system design, it can be inserted as shown in the schematic below where the resistance and the current in the circuit can be adjusted by rotating the trimmer. Sensor voltage is adjusted according to the current going to the sensor circuit. Given the voltage range for the operation of the sensor, resistors R1 and R2 are chosen with values that provide the appropriate minimal resistance, accounting for margin. Then, inserting trimmer VR1 provides maximum resistance and accounts for the margin over the maximum voltage. Since trimmers have essentially infinite resolution, a single-turn trimmer is capable of providing the desired level of accuracy in surveillance system sensor designs. In addition to selecting the resistance value, it is important to consider the required resistance tolerance. The tolerance may become critical if it is a small resistance range, which sometimes is the case in surveillance system sensors.



3313

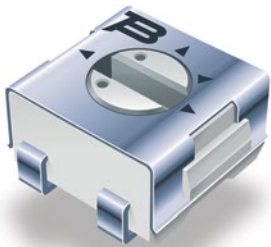

3314

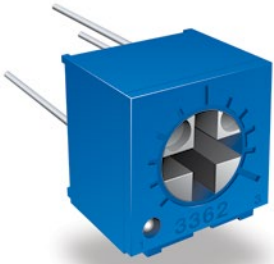

3362

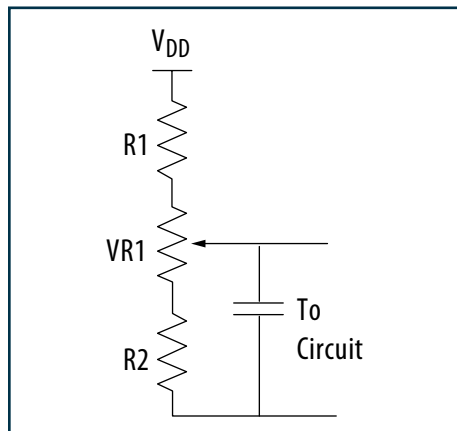
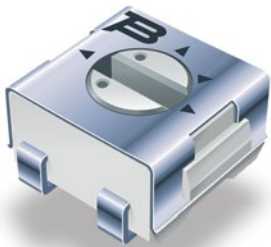

Figure 1 | Typical trimmer circuit

Placement of the trimmer will help determine the appropriate package for the application. Since adjustment may be necessary, the trimmer should be accessible and unobstructed from other components. A variety of package styles are available to make the trimmer accessible, such as board edge and surface mount styles, depending on the board real estate available and the housing that will be used. Miniature packages are available, requiring as little as ¼ inch x ¼ inch of board space. Once the surveillance system electronics have been assembled, the resistance value of the trimmer can be conveniently modified by turning the rotor. This ensures that the trimmer is within the tolerance of the system and the resolution is optimal.



3313



3314

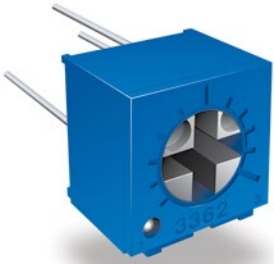

3362

Benefits

Customers expect surveillance system sensors to work as specified every time and operate efficiently. When implemented properly, a trimmer will provide continually reliable operation of the surveillance system sensor. Expertise and design advice are available from Bourns, a leader in resistive products and creator of the original trimming potentiometer over half a century ago. Bourns offers a wide range of sealed, unsealed, single-turn, and multiturn trimmers to suit a wide range of designs. Three models of sealed Bourns® trimmers are especially well-suited for surveillance system sensor designs, namely Bourns® Models 3313, 3314, and 3362.

For the surveillance system sensor application, the trimmer model chosen is generally at or below 100 Ω , such as a 100 Ω 3313J-1-101E, 3314J-1-101E, or 3362P-1-101E. Each model provides benefits to a design, including the 100-turn life cycle of Bourns® Model 3313. This trimmer can be adjusted within the circuit since a rotor stop is designed into the part. Its plastic housing helps ensure long life, and makes it compatible with designs using radio frequency (RF) components in close proximity, which is especially important when wireless interfaces are featured in the surveillance system. Bourns® Models 3313, 3314, and 3362 are single-turn trimmers with cermet construction, and the 'J' style is appropriate for the surveillance system design. Bourns® Model 3314 offers the advantage of high compatibility with the surface mount process and pick and place equipment, including that with a vacuum lock. This industrial trimmer meets the following standards: EIA, EIAJ, IPC, and VEC SMD. Bourns® Model 3362 features a rotor designed to interface with automatic machines for adjustment and comes in a miniature package. The resistance tolerance of Model 3362 has a 10 percent envelope, though the tolerance can be tightened for this model.



3313



3314

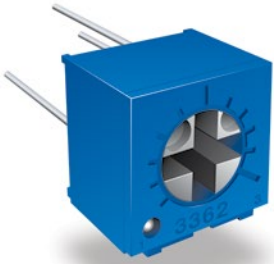

3362

Conclusion

The key features that make trimmers ideal for use in surveillance system sensor designs include accuracy, reliability, and sensitivity. Semi-sealed or dustproof trimmers lack some of the robustness sealed trimmers offer. With a sealed package and cermet construction, Bourns® Models 3313, 3314, and 3362 provide reliability even in prolonged exposure to damp conditions. Superior resistance tolerance, such as 10 percent or less is available in the Bourns® Model 3362. The convenience and reliability of adjusting the trimmer prior to shipping the surveillance system sensor offers tremendous savings potential for cost and time, making it possible to ship each unit pre-calibrated and ready for immediate installation.

References

Datasheets for the Bourns® 3313, 3314, and 3362 trimmer models can be found online at:

- <http://www.bourns.com/data/global/pdfs/3313.pdf>
- <http://www.bourns.com/data/global/pdfs/3314.pdf>
- <http://www.bourns.com/data/global/pdfs/3362.pdf>

Additional information regarding trimmers, including a primer on trimmer operation, is accessible in Bourns online technical library.

- <http://www.bourns.com/data/global/pdfs/trmrpmr.pdf>

For further technical support and for complete trimmer solutions, please visit

www.bourns.com

"Bourns" is a registered trademark of Bourns, Inc. in the U.S. and other countries.
COPYRIGHT © 2010 • BOURNS, INC. • 06/10 • e/T1014